

1989 VOLVO 740

Contents

A comprehensive index is located at the back of this manual.

[Presentation](#)

[Instruments and controls](#)

[Body and interior](#)

[Starting and driving](#)

[Wheels and tires](#)

[In case of emergency](#)

[Car care](#)

[Service and routine
maintenance](#)

[Specifications](#)

[Index](#)

All information, illustrations and specifications contained in this manual are based on the latest product information available at the time of publication. Volvo reserves the right to make model changes at any time, or to change specifications or design, without notice and without incurring obligation.

pg. 2 This manual deals with the operation and care of your Volvo

Welcome to the world-wide family of Volvo owners. We trust that you will enjoy many years of safe driving in your Volvo, an automobile designed with your safety and comfort in mind. To ensure your satisfaction with this vehicle, we encourage you to familiarize yourself with the equipment descriptions, operating instructions and maintenance requirements/recommendations in this manual. We also urge you

and your passengers to wear seat belts at all times in this (or any other) automobile. And, of course, please do not operate a vehicle if you may be affected by alcohol, medication or any impairment that could hinder your ability to drive.

Your Volvo is designed to meet all applicable safety and emission standards, as evidenced by the certification labels attached to the door opening sheet metal and on the left wheel housing in the engine compartment. For further information regarding these regulations, please contact your dealer.

pg. 3 Seatbelts: "Something We Believe In"

Despite our strongest recommendation, and your best intentions, not wearing a seatbelt is like believing "it'll never happen to me!", Volvo urges you and all adult occupants of your car to wear seatbelts and ensure that children are properly restrained, using an infant, car or booster seat determined by age, weight and height.

Fact: In every state, some type of child-restraint legislation has been passed. Additionally, some states are seriously considering, or have already made it mandatory for occupants of a car to use seatbelts

So, urging you to 'buckle up' is not just our recommendation - its becoming the law! The few seconds it takes to buckle up may one day allow you to say, "Its a good thing I was wearing my seatbelt."



pg. 4 Presentation

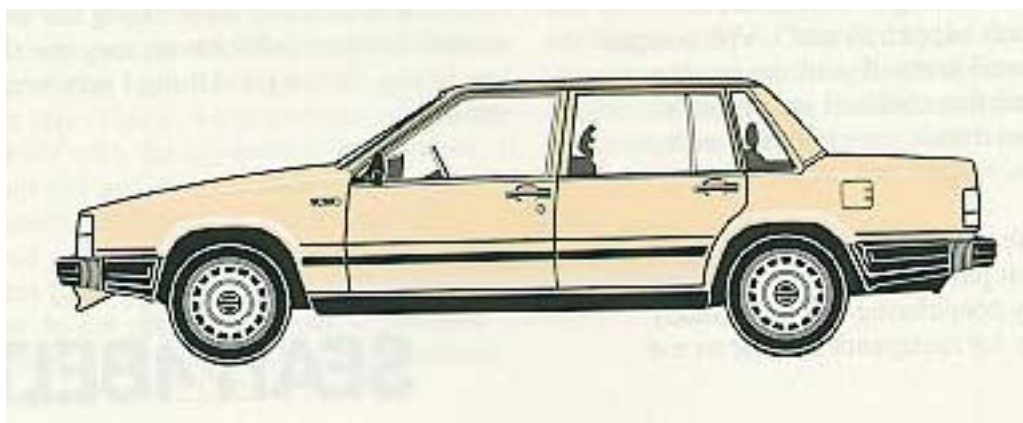

This Owner's manual provides information on driving and maintaining your Volvo
It should be noted that there are certain differences among model versions and market requirements;

thus, you may find features described and/or pictured in this manual that do not appear on your car. Should you require more detailed information with regard to adjustments or repairs please contact your Volvo dealer.

Do not export your Volvo to another country before investigating that country's applicable safety and exhaust emission requirements. In some cases it may be difficult or impossible to comply with these requirements. Modifications to the emission control system(s) may render your Volvo not certifiable for legal operation in the U.S., Canada, and other countries.

pg. 5 Keys

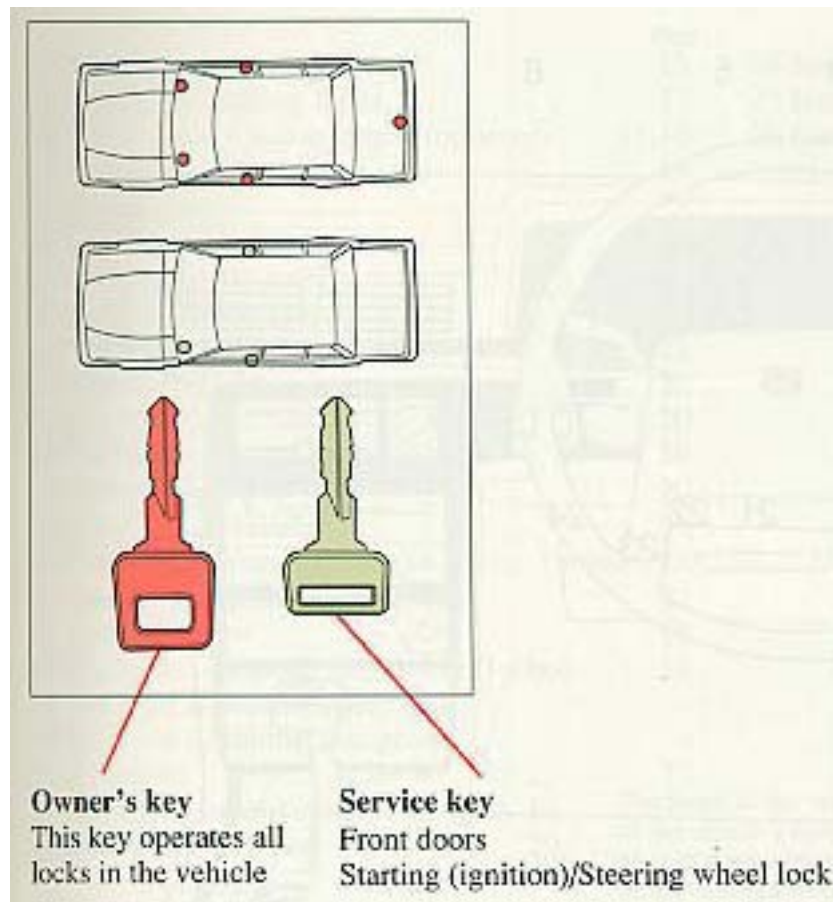

The key number codes are stamped on a separate tag supplied with the keys. This tag should be separated from the key ring and kept in a safe place.

The double-sided tape on the back of the tag can be used to secure it safely.

In the event the original keys are lost, duplicates may be ordered from your Volvo dealer.

The central locking system is described in detail in section "Door and locks".



[Top of Page](#)

1989 VOLVO 740

Instruments and controls

pg. 6 Instruments, Switches and controls

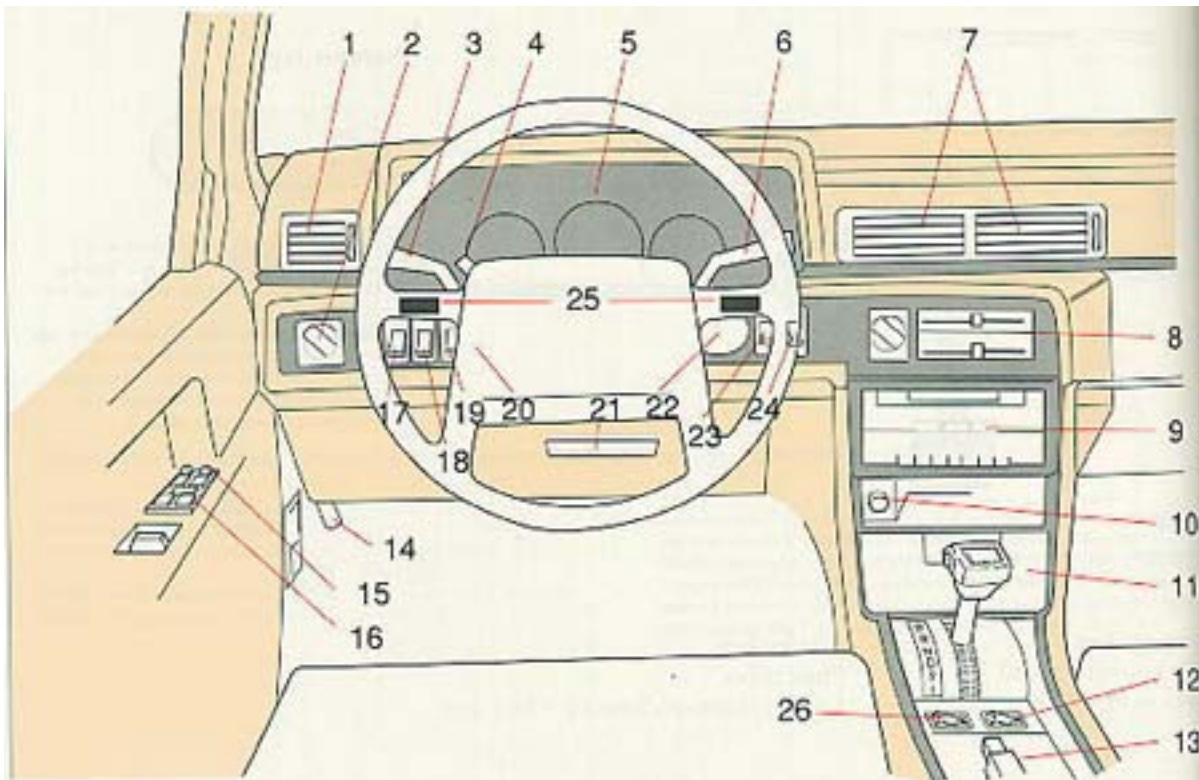

pg. 7 Instruments, Switches and controls

- | | |
|---|---|
| 1 Air louver | 23 |
| 2 Headlights, parking lights | 17 |
| 3 Turn signals. Cruise Control (optional) | 14-
16 |
| 4 Hazard warning flashers | 14 |
| 5 Instruments | 8 |
| 6 Wiper/washer | 15 |

7 Air louvers	23
8 Heating and ventilation	23- 25
9 Audio cassette/tuner	22
10 Cigarette lighter	20
11 Ash tray	20
12 Electrically-heated passenger seat	19
13 Parking brake	20
14 Hood release handle	39
15 Power door mirrors (GLE-16 Valve, Turbo)	28
16 Electrically operated windows	21
17 Rear fog lamps	18
18 Fog lights (optional, standard on Turbo)	18
19 Space for additional equipment	-
20 Space for additional equipment	-
21 Air louver	23
22 Starting (ignition) switch/steering wheel lock	13
23 Electrically operated sun roof	29
24 Rear window demister	19
25 Horn	-
26 Electrically-heated driver's seat	19

The pages in this section provide a detailed description of the vehicle's instruments and controls. Note that vehicles may be equipped differently, depending on special legal requirements, etc.

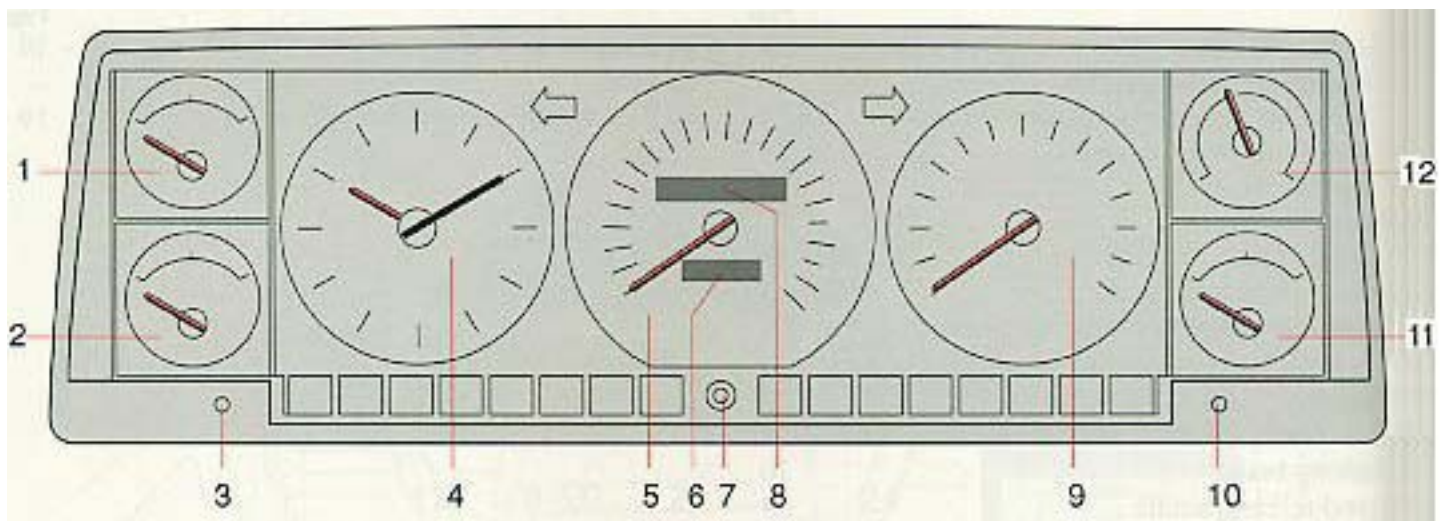

NOTE: Canadian model speedometers/odometers indicate kilometers only.

- 1 Voltmeter (Turbo models)
- 2 Fuel gauge
- 3 Clock reset knob
- 4 Quartz crystal clock
- 5 Speedometer
- 6 Trip odometer *
- 7 Trip odometer reset knob
- 8 Odometer
- 9 Tachometer
- 10 Instrument panel lamps rheostat
- 11 Temperature gauge
- 12 Boost gauge (Turbo models)

* The last digit indicates 1/10 mile/kilometer. A black number on a white background = original speedometer. A red number on a white background = replacement speedometer.

pg. 9 Instruments

Quartz crystal clock

To reset the hands, push in the reset knob and turn.

Tachometer

Reads thousands of engine rpm. Engine should not be operated in red range.

Trip odometer

Used for measuring shorter distances. (last figure represents 1/10 mile or km)

Trip odometer reset knob

Push in to reset

Temperature gauge

The pointer should be approximately midway on the gauge face when driving. If the pointer approaches the red range repeatedly, check coolant level and fan belt tension. Do not drive the car with the pointer in the red range. See sections "Coolant" and "Drive belts".

WARNING!

Allow engine to cool before adding coolant.

Fuel gauge

The fuel tank capacity is approx. 15.8 US gals (60 liters). The red range represents approx. 2.4 US gals. (9 liters). See "Refueling" for further information.

Instrument panel lamps rheostat

Clockwise = brighter.

Counterclockwise = dimmer.

Voltmeter

(Turbo-engine cars only) The voltmeter indicates the voltage in the electrical system and thereby also the state of the battery. While the car is being driven the pointer should be within the black field. Should the pointer point to the upper or lower red field when driving, this may indicate some fault in the electrical system.

Boost pressure gauge

(Turbo-engine cars only) The boost pressure gauge is divided into sections.

Black section: The engine acts as a normally-aspirated engine. Best fuel economy is achieved while driving in this range. Yellow section: The turbo is providing boost pressure.

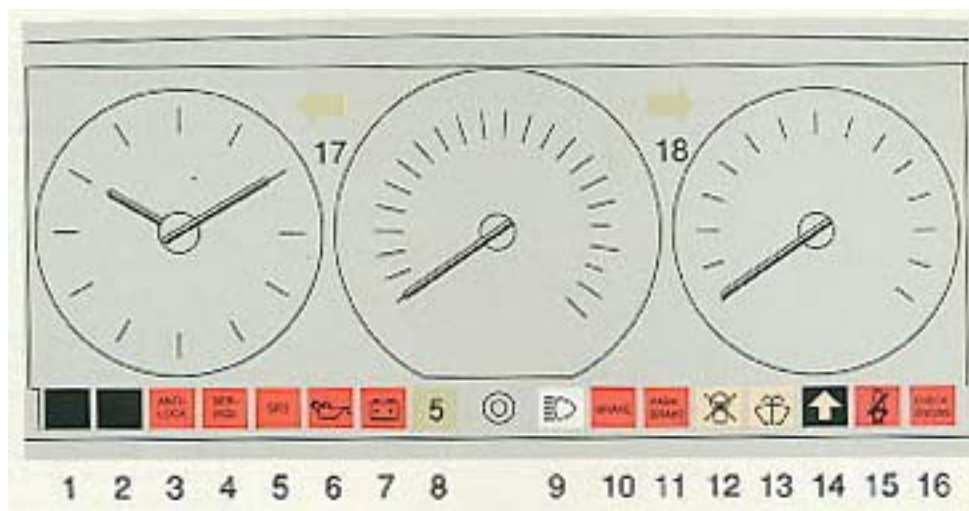

- 1 (Not in use)
- 2 (Not in use)
- 3 ABS-system, [see p. 12](#)
- 4 Service reminder light, [see p. 12](#)
- 5 SRS malfunction light
- 6 Low engine oil pressure
- 7 Alternator not charging
- 8 Overdrive (5th gear) engaged (Turbo with manual transmission)
- 9 High beams
- 10 Brake failure
- 11 Parking brake applied
- 12 Bulb failure
- 13 Low washer fluid level.
If the lamp glows continuously when the engine is running, there is only about 1/2 - 1 US qts. remaining in the washer fluid reservoir.
- 14 Shift indicator light
(manual transmission models) or 4th gear disengaged, automatic transmission
- 15 Fasten seat belts
- 16 Check engine, [see p. 11](#)
- 17 Turn signal, left
- 18 Turn signal, right

pg. 11 Warning lights

The warning lights described on this page should never stay on when driving

When the ignition key is turned on, and before the engine starts, all of the warning lights should be on to test the function of the bulbs. Should a light not go off after the engine has started, the system indicated should be inspected. However, the parking brake reminder light will not go off until the parking brake is fully released.



Alternator warning light

If the light comes on while the engine is running, check the tension of the alternator drive belt as soon as possible.

NOTE: This warning light is illuminated if the alternator is not charging. However, parking brake, brake failure and bulb failure warning lights will be illuminated at the same time due to the design of the system.



Check Engine warning light

If the light comes on (or stays on after the vehicle has started), the Engine Check diagnostic system has detected a fault. Drive to an authorized Volvo dealer for inspection.



Oil pressure warning light

If the light comes on during driving, the oil pressure is too low. Stop the car and then stop the engine immediately and check the engine oil level. See section titled "Engine oil".

After hard driving, the light will come on occasionally when the engine is idling. This is normal, provided it goes off when the engine speed is increased.

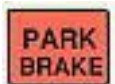

Parking brake reminder light

This light will be on when the parking brake (hand brake) is applied. The parking brake lever is situated between the front seats.

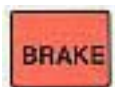

Brake failure warning light

If the light comes on while driving or braking, this indicates that the brake fluid level is too low. Stop immediately, open the hood and check the brake fluid level in the reservoir (see section "Engine compartment" for reservoir position)!

WARNING!

If the fluid level is below the MIN mark in the entire reservoir: do not drive. Tow the car to a garage and have the brake system checked/repared.

If the fluid level is above the MIN mark, or is below the MIN mark in only one of the two parts of the reservoir, drive with caution to an authorized Volvo dealer for inspection of the system.

pg. 12 Indicator lights

Service reminder light

This light will come on at 5000 mile (8000 km) intervals. It is a reminder to the driver to have the engine oil and oil filter changed. The light will stay on 2 min. after start until reset by the servicing dealer.

Anti-lock Brake System ABS

ABS brakes are designed to prevent the brakes from locking under severe braking conditions. If the light comes on while driving, there is a malfunction of the ABS system (the standard braking system will still function), and the car should be driven to an authorized Volvo dealer for inspection.

The system "senses" when the brakes begin to lock. regulates the brake pressure and thereby helps prevent the brakes from locking. When the system is activated, you may be aware of a slight vibration in the brake pedal. The switching sound of the control unit in the engine compartment may also be audible. This is quite normal.

Note that the ABS system does not increase the total braking capacity of your car. It does, however, enable you to steer and helps to retain better control of the vehicle.

Shift indicator light (Manual transmission cars only)

The Volvo shift indicator light (S.I.L.) is a device designed to help you get even better gas mileage from your Volvo car. Studies have shown that the best fuel economy is obtained by shifting gears at low engine rpm and high relative engine load. The Volvo S.I.L. is calibrated to show you when to shift for improved mileage without sacrificing smooth acceleration.

Use of the S.I.L. is simple. Shift to the next higher gear as soon as the light comes on. You may find after using the S.I.L. for some time that your natural shifting rhythm will adapt to the S.I.L.'s suggestion. Some drivers may even shift before the light comes on.

Obviously, there will be times when you need to shift later than the light would indicate, for example, when climbing hills or trailer towing. Using the light regularly, however, should result in a mileage

improvement of six percent or more, depending on how you normally drive.



SRS

SRS Supplemental Restraint System

(optional on certain models)

If the light comes on (or stays on after the vehicle has started, the SRS diagnostic system has detected a fault. Drive to an authorized Volvo dealer for inspection. (See section "SRS for further information.)

Programming instructions for shift indicator

If the current supply to the control unit is cut (battery disconnected), the control unit will have to be re-programmed as the control unit memory will be erased.

Drive the car in each gear. First gear not necessary, for approximately 8 seconds.

The gear change indicator light will flicker once (0.5 seconds), as each gear is programmed.

NOTE: Remove the foot completely from the clutch pedal after each gear change when programming the control unit.



Bulb failure warning light

The light will come on if any of the following bulbs are defective:

one of the low beam headlights

one of the tail lights

one of the brake lights when the brake pedal is depressed.

Check the fuse and bulb. See sections titled "Replacing bulbs" and "Fuses".

Should the warning light come on after a defective outside bulb has been replaced, the corresponding bulb on the other side of the car should also be replaced.

pg. 13 Starting (ignition) switch



Starting (ignition) switch/steering wheel lock

The steering wheel lock might be under tension when the car is parked. Turn the steering wheel slightly to free the ignition key.

A chime will sound if the starting key is left in the ignition lock and front door on the driver's side is opened.



pg. 14 Turn signals, Hazard warning flasher



Turn signals

1 Lane change position. In maneuvers such as lane changing, the driver can flash the turn signals by moving the turn signal lever to the First stop and holding it there. The lever will return to the neutral position when released.

2 Signal lever engaged for normal turns.

NOTE: Defective turn signal bulb will cause turn signal indicator and remaining signal lights to flash more rapidly than normal.



3 High beam/low beam switch (headlights on).

Move the lever towards the steering wheel past the headlight flasher position and release it.

3 Headlight flasher (headlights off).

Move the lever towards the steering wheel. The headlight high beam will be on until the lever is released.

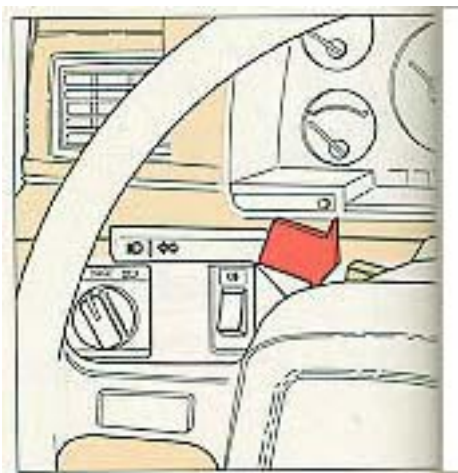

Hazard warning flasher

The four-way flasher should be used to indicate that the vehicle has become a traffic hazard.

NOTE: Regulations regarding the use of the hazard warning flasher may vary from state to state.

pg. 15 Windshield, Tailgate wipers/washers

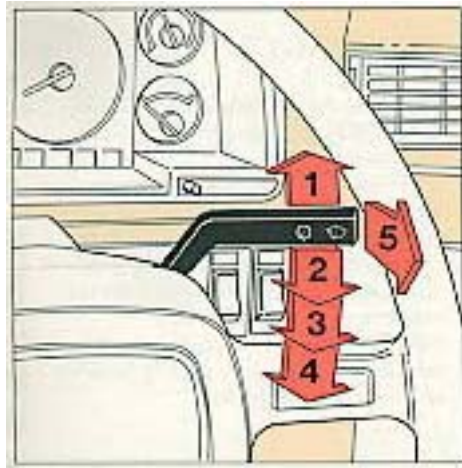

Wiper/washer

1 Intermittent wiper.

With switch in this position, the wipers will sweep approximately every seventh second.

2 "Single sweep" position.

Switch returns automatically when released.

3 Wipers, low speed.

4 Wipers, high speed.

5 Windshield wiper/washer.

The wiper will make 2-3 complete sweeps after the lever is released.



Tailgate window wiper/washer (wagon)

The tailgate window wiper/washer is operated by a switch at the end of the wiper lever.

1 The wiper operates continuously.

2 Intermittent position: the wiper strokes approximately every 10 seconds.

3 Tailgate washer.

After the button is released the wiper strokes 2-3 additional times before stopping.

The electrical circuit is protected by fuse 14, located in the central electrical unit. See the section entitled "Fuses".

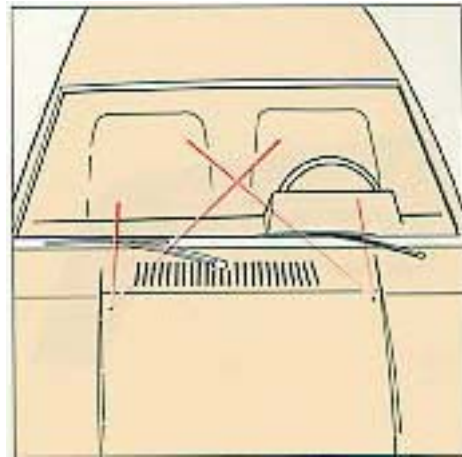

Adjusting washer nozzles

The washer jets should spray the windshield as shown. Use the edge of a small screwdriver to adjust the nozzles, if necessary.

Washer fluid reservoir

The washer fluid reservoir is located in the engine compartment and holds approx. 0.5 US gal. (2.0 liters) on sedan models and approx. 0.8 US gal (3.2 liters) on wagon models.

During cold weather, the reservoir should be filled with windshield washer solvent.

pg. 16 Cruise control

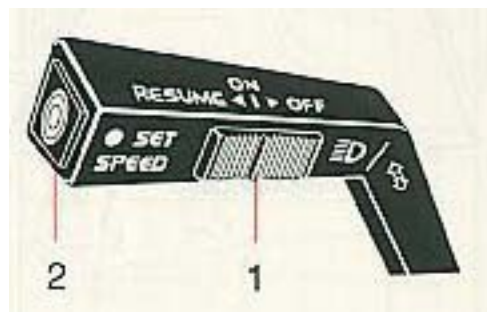

Cruise control

(optional on certain models)

The cruise control switches are located on the turn signal switch lever.

To engage and set desired speed:

1. Set switch (1) to ON.
2. Accelerate to desired cruise speed.

NOTE: The cruise control cannot be engaged at speeds below 22 mph (35 km).

3. Depress SET SPEED switch (2).

Operating brake pedal or clutch pedal (where applicable)

This will automatically disengage the cruise control. Previously selected cruise speed is retained in the memory and by momentarily setting the switch to RESUME position that speed will be re-engaged.

WARNING!

The vehicle will accelerate very quickly should there be a substantial speed differential when the switch is reset that the vehicle be accelerated manually and the switch reset to RESUME once the speed differential has been reduced.

Acceleration

Momentary acceleration, such as for passing, does not interrupt cruise control operation. The previously selected speed will be maintained without having to set switch to RESUME.

To disengage the cruise control system:

Set switch (1) to position OFF, or depress brake pedal, or depress clutch pedal (where applicable). Switching off the starting (ignition) switch will automatically disengage the cruise control system.

WARNING!

The cruise control should not be used in heavy traffic or when driving on wet or slippery roads. If the gear shift is moved to Neutral while the cruise control is engaged, then depress the brake pedal momentarily, or set the cruise control switch (1) to OFF. This will disengage the cruise control and prevent overrevving the engine.

NOTE: When driving on a grade, actual vehicle speed may vary slightly from the set cruise control speed.



Headlights and position lights

□ All lights off

☞ Parking lights on

☞ Headlights and parking lights are on if starting (ignition) switch is in position I or II.

If the headlight switch is in position ☞ all lights will go out when starting switch is switched off.



With the headlight switch in position ☞ the parking lights will stay on. Switch from high to low beams, and vice versa, by moving the turn signal switch lever on the left side of the steering column towards the steering wheel.

pg. 18 Rear fog lights, Front fog lights, Power antenna

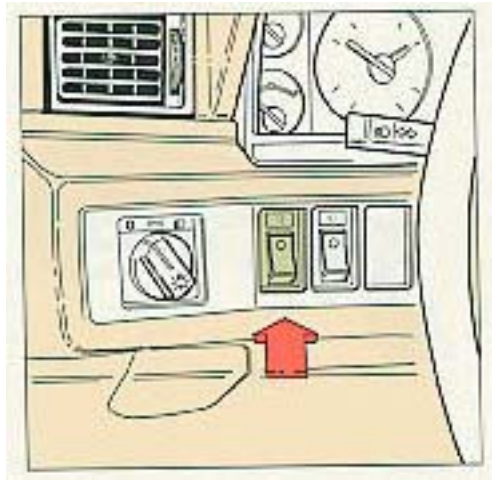

Rear fog lights

The rear fog lights are considerably brighter than the normal tail lights and should be used only when atmospheric conditions, such as fog, rain, snow, smoke or dust reduce the daytime or nighttime visibility of other vehicles to less than 500 ft. (152 meters). The headlights must be switched on.

Note that local regulations governing the use of these lights may vary.

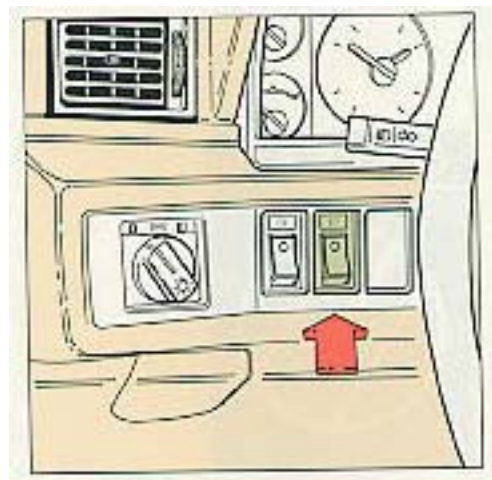

Auxiliary front fog lights (optional on certain models)

Auxiliary front fog lights can be switched on only with the low-beam headlights on.

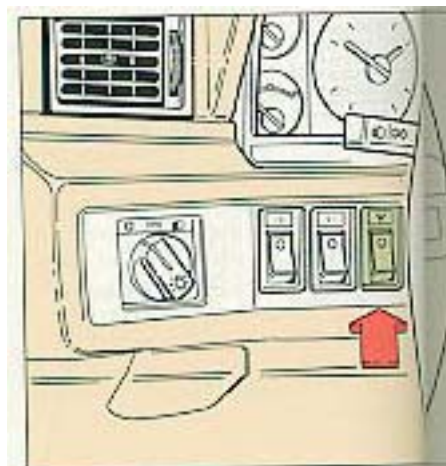

Power antenna

The power antenna switch can be used to retract the antenna when the audio system is turned on. This will permit operation of the cassette drive with the antenna in the down position.

CAUTION: Always lower the antenna when entering a garage or car wash to avoid antenna damage.

pg. 19 Rear window demister. Heated front seats



Rear window demister

To operate, depress the switch. The indicator lamp in the switch will come on. The system will be switched off automatically after 10-15 minutes or when the starting (ignition) key is switched off.

Heated front seats

The front seats are equipped with electrically-heated backrests and seat cushions. The heating is thermostatically-controlled and cuts out automatically. Use the switches to disengage the seat heating manually when the seat is not occupied.



Extra heating (certain models)

Switch on or off as required. When switched on, the seats are automatically heated and when the optimal temperature is reached, the heating automatically switches off.

The passenger seat will only be heated when it is occupied.

pg. 20 Parking brake, Cigarette lighter, Ash trays

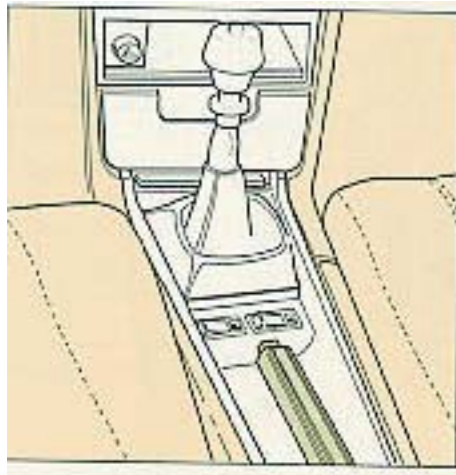

Parking brake (hand brake)

The lever is situated between the front seats. The brake is applied to the rear wheels.

WARNING!

Always use the parking brake (hand brake) when parking. On hills, also turn the front wheels toward the curb.

In order to obtain the best possible performance of the parking brake, the brake linings should be broken in. See section titled "Brake system".

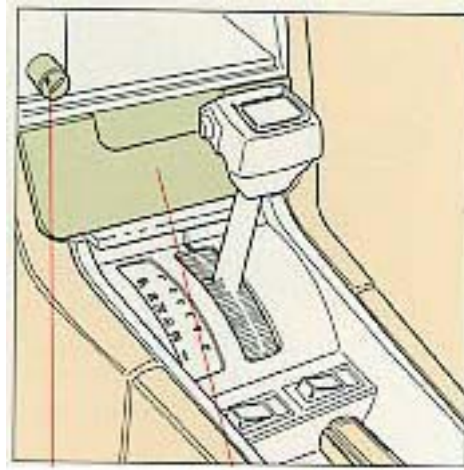

lighter Ash tray

Cigarette lighter

To operate, depress the knob fully. When the knob automatically releases, the cigarette lighter is ready for use.

The starting (ignition) switch must be switched on (to position I or II) for the cigarette lighter to function.

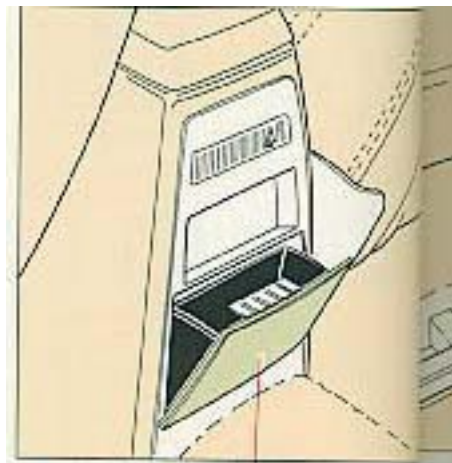

Rear seat ash tray

Ash trays

To remove the ash trays depress the center spring and remove.

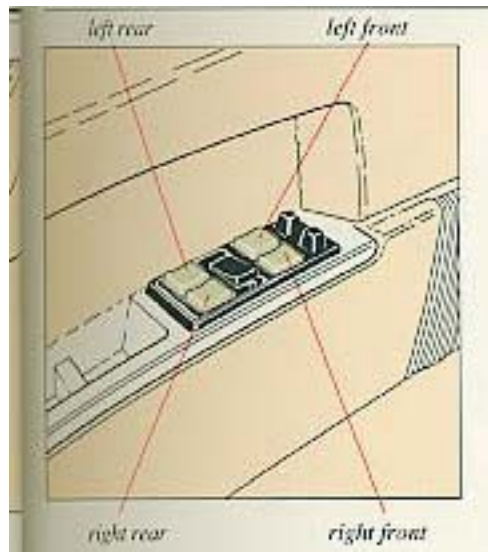

Electrically-operated windows (GLE, Turbo models)

The electrically operated windows are controlled by switches from the driver's armrest as shown in the above illustration. The starting (ignition) switch must be ON (position II) for the electrically operated windows to function. The window is lowered if the rear part of the switch is pressed and raised if the front part of the switch is pressed.

WARNING!

Remove the starting (ignition) key when children are left unattended in the vehicle.

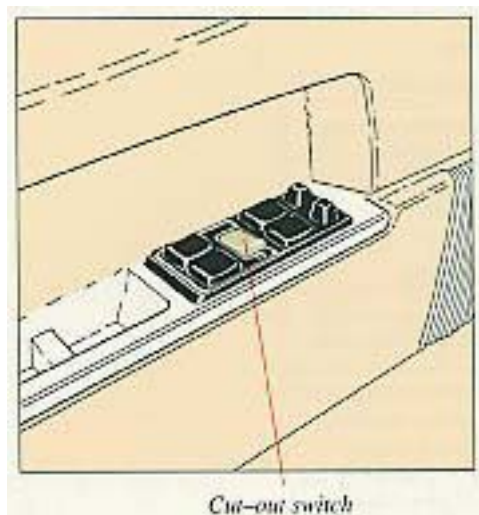

Cut-out switch for electrically-operated rear-door windows

If the car is equipped with rear door power windows, this function can be disabled by a switch located on the driver's door armrest. This switch is positioned 90° in relation to the other switches.

● The rear door windows can be raised or lowered with the respective door switch as well as the

switch on the driver's door.

○ The rear door windows **cannot** be raised or lowered with the respective door switch but instead **only** with the corresponding switch on the driver's door.

pg. 22 Audio Cassette/Tuner controls and indicators

Controls and indicators

For complete operating instructions, maintenance guidelines, and specifications, please consult your Audio Cassette/Tuner Instruction Booklet. The Booklet also contains information on radio reception and the radio antenna.

Multipath distortion

FM signals are typically "line-of-sight" and very reflective. Their reflectivity to objects such as buildings, mountains or even other passing vehicles causes the condition known as multipath distortion. This distortion is the result of the reflected signal and the direct signal reaching your antenna at slightly different times causing a cancellation of all signals. This condition will sound like hissing or static. Very little can be done to eliminate this problem, however, lowering the treble on your radio could help mask these disturbances thereby allowing you to achieve optimum pleasure from your audio system.

pg. 23 Heating and ventilation

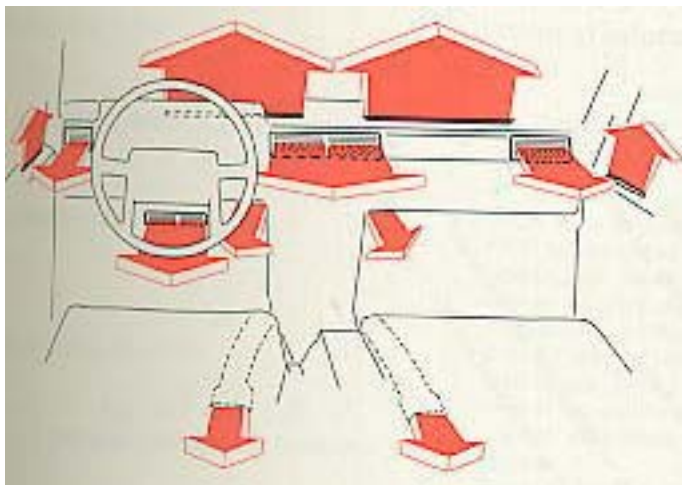

Heating and ventilation

Your Volvo is equipped with a heating system combined with air conditioning.

Depending on which function you select, warm or cool/cold air is distributed to the different parts of the passenger compartment. An additional driver's air louver is located beneath the steering column and can be adjusted upwards, downwards, or closed as desired.

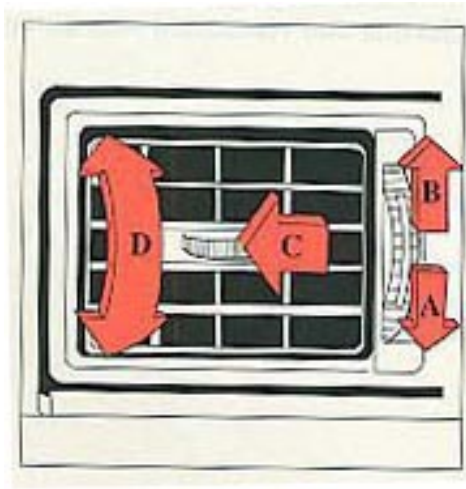

Air louvers (dash)

A Open

B Closed

C Directing air flow horizontally

D Directing air flow vertically

A certain amount of air will always enter through the dash air louvers as long as they are open, independently of the position of the air distribution control.

Close the dash air louvers to obtain maximum air flow to floor or windshield.

pg. 24 Heating and ventilation

Heating and ventilation with air conditioning

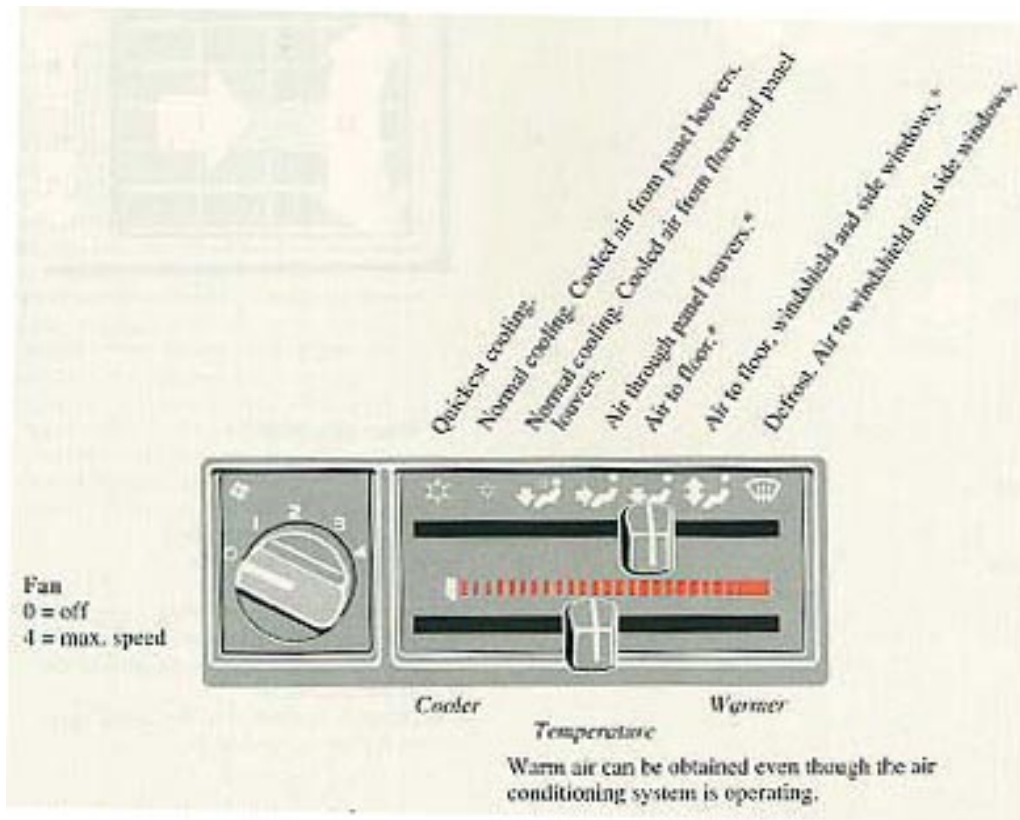

* Air conditioning unit not engaged.

pg. 25 Heating and ventilation

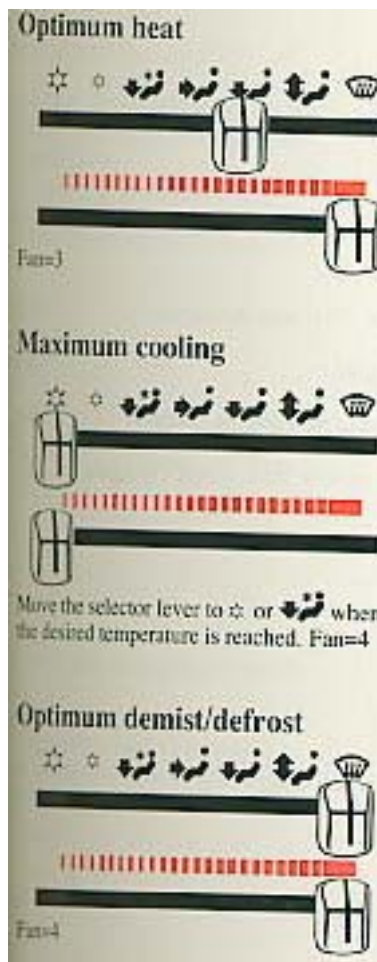

Additional information and tips

- The air conditioning compressor is engaged only if the temperature is above 46°F (+8°C).
 - In all three air conditioning positions the fan runs at speed 1 if the switch is at "0". This is a safety measure to prevent formation of ice in the system.
 - When the outside air is contaminated with exhaust gases, smoke, etc. (as when driving through a tunnel), move the lever to ☒ for a few minutes. In this position very little air is drawn in to the passenger compartment from outside. Do not, however, leave the lever in this position for more than 10-15 minutes, since hardly any fresh air is being supplied.
- Regulate the temperature with the temperature control lever.
- The air conditioning unit functions best if used regularly.

Always keep the air inlet grill in front of the windshield clear of snow in winter.



[Contents](#) | [Top of Page](#)

1989 VOLVO 740

Body and interior

pg. 26 Body and Interior

The seats, seat belts, doors, etc. are described on the following pages.

Front seats	27
Rear-view/side-view mirrors	28
Interior light, sun roof	29
Child safety	30
Seat belts	32
Supplemental Restraint System (SRS)	34
Doors and locks	36
Child safety locks, Trunk lid (sedans)	37
Trunk, long load storage	38
Hood	39
Passenger compartment, storage spaces	40
Tailgate, Child safety lock (wagons)	41
Station wagon tailgate, storage spaces	42
Folding rear seat (wagon)	43
Removing seat cushions, Securing cargo	44
Cargo space lighting, spare tire, jack (wagon)	45

pg. 27 Front seats

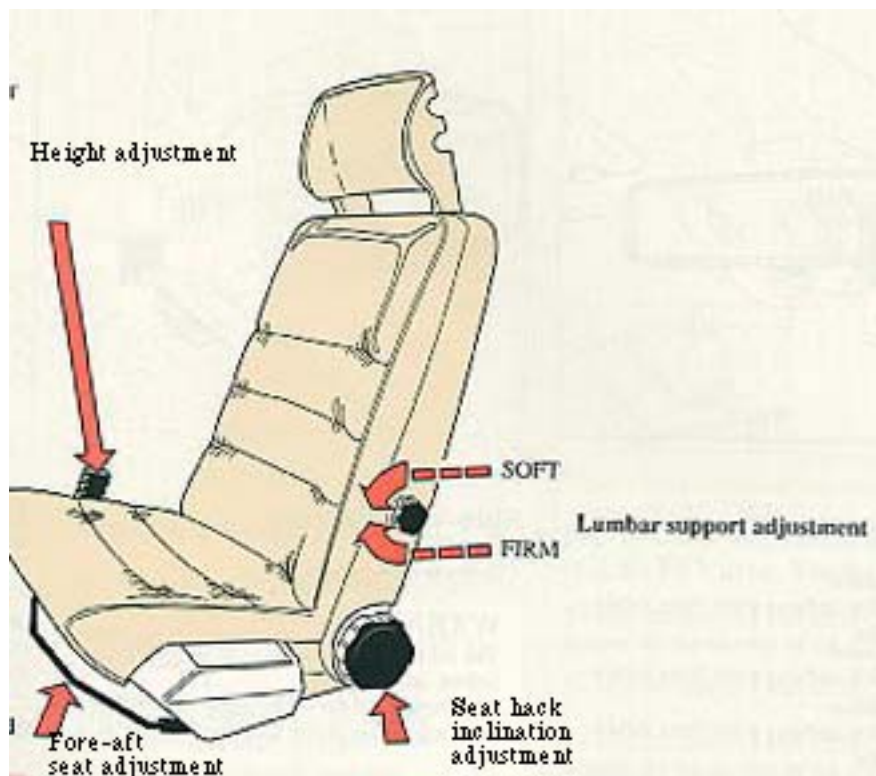

Height adjustment

The front section of the seats can be adjusted to three height positions and the rear section to four.

Lever forward = front height adjustment

Lever rearward = rear height adjustment

Do not adjust the seat while driving.

Fore-aft seat adjustment

Pull control upward, then slide seat forward or rearward to desired position.

Make sure that the seat is properly secure when you release the control.

WARNING!

For your safety, never adjust the seat while driving. The seat should be adjusted so the brake pedal can be fully depressed.

Seat back inclination adjustment

Rotate control clockwise to tilt seat back rearward.

Rotate counterclockwise to tilt seat back forward.

Note that body weight must be shifted to allow seat back to move forward or rearward.

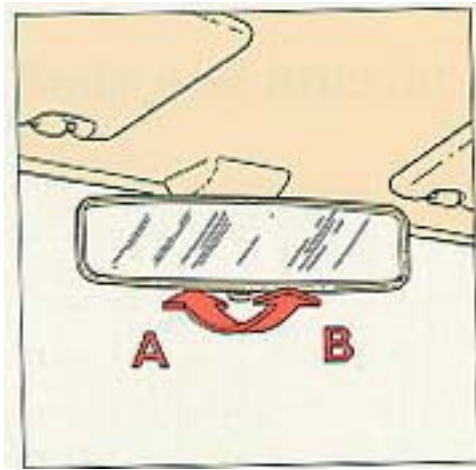

Rear-view mirror

A Normal position

B Night position, reduces glare from following headlights

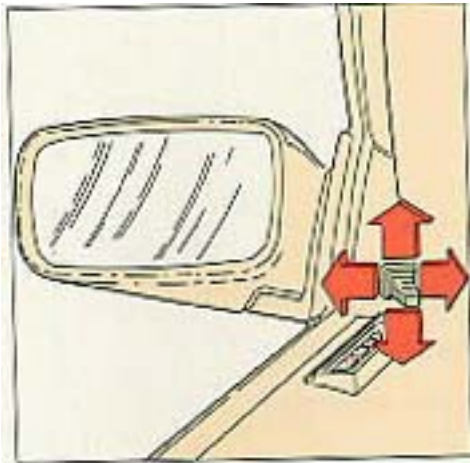

Side-view mirrors

Use the lever to adjust.

WARNING!

The mirrors should always be adjusted before driving.

Objects seen in the wide-angle right sideview mirror are closer than they appear to be.

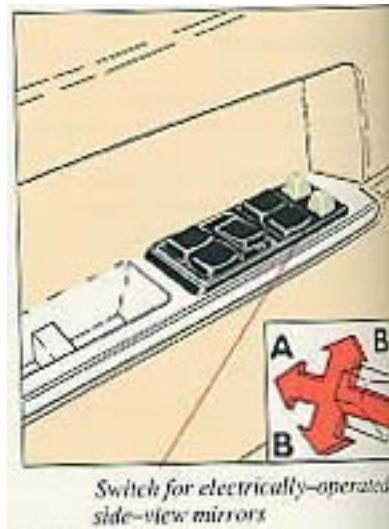

Electrically-operated side-view mirrors

The control switches are located in the driver's door armrest.

A Adjustment sideways

B Adjustment up/down

CAUTION:

Never use ice scrapers made of metal as they can easily scratch the mirror surface.

pg. 29 Interior light, Sun roof



Interior light

1. Light always on.
2. Light always off.
3. Light is on when either of the front or rear doors are opened.

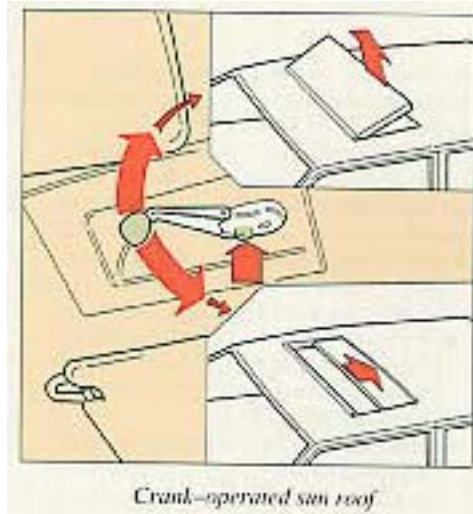

Sun roof (certain models)

The sun roof can be used in two ways: as a conventional sliding roof, or the rear edge can be raised or lowered to provide various ventilation positions.

- 1 Depress the button prior to cranking.
- 2 Counter-clockwise: sliding roof.
- 3 Clockwise; ventilation positions.

WARNING!

For added safety, always have the crank folded during driving.

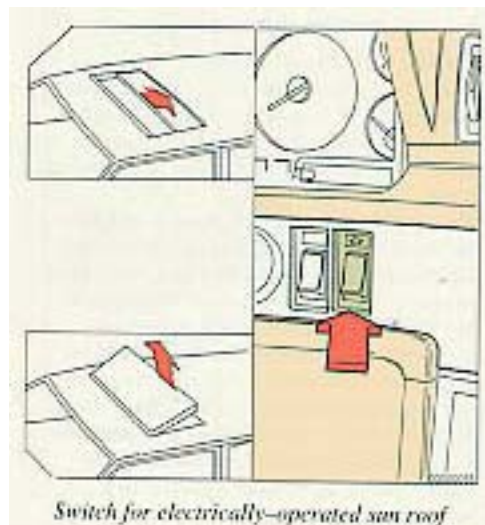

Electrically-operated sun roof (GLE-16 Valve, Turbo)

To open the sun roof as a sliding roof, depress the top portion of the rocker switch. To raise the rear edge of the sun roof, depress the bottom portion of the switch. To close the sun roof, depress the side of the rocker switch opposite the side used to open the sun roof.

NOTE: In case of sun roof malfunction see "Service diagnosis".

pg. 30 Child safety

Child safety

Volvo recommends the proper use of restraint systems for all occupants including children. Remember that, regardless of age and size, a child should always be properly restrained in a car.

Restraint systems for children are designed to be secured in the vehicle by lap belts or the lap portion of a lap-shoulder belt. Such child restraint systems protect children in cars in the event of an accident only if they are used properly. However, children could be endangered in a crash if the child restraints are not properly secured in the vehicle. Failure to follow the installation instructions for your child restraint can result in your child striking the vehicle's interior in a sudden stop.

Holding a child in your arms is NOT a suitable substitute for a child restraint system. In an accident, a child held in a person's arms can be crushed between the vehicle's interior and an unrestrained person. The child could also be injured by striking the interior, or by being ejected from the vehicle during a sudden maneuver or impact. The same can also happen if the infant or child rides unrestrained on the seat. Other occupants should also be properly restrained to help reduce the chance of injuring or increasing the injury of a child.

All states and provinces have legislation governing how and where children should be carried in a car. Find out the regulations existing in your state or province. Recent accident statistics have shown that children are safer in rear seating positions than front seating positions when properly restrained. A child restraint system can help protect a child in a vehicle. Here's what to look for when selecting a child restraint system:

- It should have a label certifying that it meets applicable Federal Motor Vehicle Safety Standards (FMVSS 213-80) - or in Canada, CMVSS 213.
- Make sure the child restraint system is approved for the child's height, weight and development - the label required by the standard or regulation, or instructions for infant restraints, typically provide this information.
- **In using any child restraint system, we urge you to look carefully over the instructions that are provided with the restraint. Be sure you understand them and can use the device properly and safely in this vehicle. A misused child restraint system can result in increased injuries for both the infant or child and other occupants in the vehicle.**

- If your child restraint requires a top tether strap, consult your authorized Volvo dealer for top tether anchorage and installation information (sedan models only).

When a child has outgrown the child safety seat (approximately age 4- 5 years, depending on size) you should use the rear seat with the standard seat belt fastened. The best way to protect the child here is to place the child on a cushion so that the seat/lap belt is properly located on the hips.

A specially designed and tested safety cushion for this purpose can be obtained from your Volvo dealer. If necessary, an extra seat is available for use in the luggage compartment of station wagon models. This seat is designed for two children, each up to 80 lbs. in weight and up to 53 inches in height.

pg. 31 Child safety

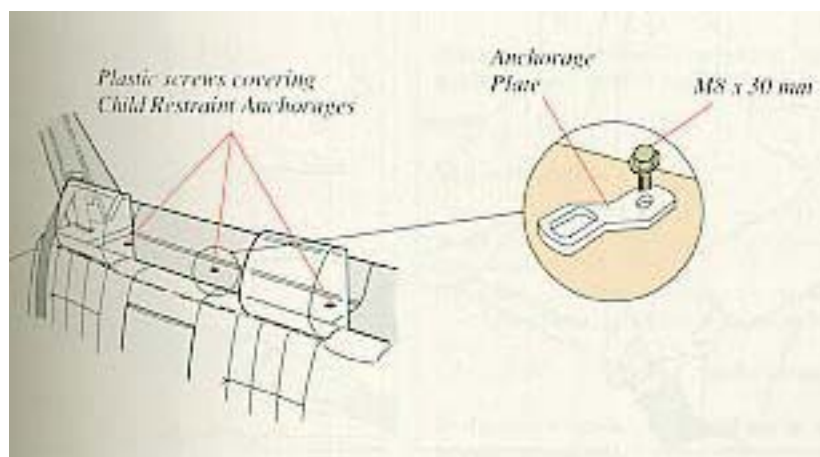

Child Restraint Anchorages

Volvo cars are fitted with Child Restraint Top Tether Anchorages in the rear seat. There are three anchorages under the rear section of the car's rear window shelf on sedans and in the back of the rear seat/largest storage bin in wagons. When the car is delivered, the holes for these anchorages are covered by plastic screws. In cars designated for Canada on top tether anchorage set will be in the glove box. In cars designated for the US a coupon good for one set, will be provided by mail. The top tether anchorage set includes the top tether anchorage plate, a M8 bolt 30 mm long and a plastic trim cover.

If another set is needed, consult your Volvo dealer.

Installing the top tether

Remove the plastic screw covering the anchorage point you want to use. This can be done with a suitable coin. The screw is removed counterclockwise. Place the top tether anchorage plate as shown in the illustration. Using the M8 bolt, tighten securely to 16 +/-2.5 ft-lb. Place the plastic trim plate over the anchorage plate, if desired.



WARNING!

Child Restraint Anchorages are designed to withstand only those loads imposed by correctly fitted Child Restraints. Under no circumstances are they to be used for adult seat belts or harnesses. The anchorages are not able to withstand excessive forces on them in the event of collision if full harness seat belts or adult seat belts are installed to them. A grown-up who uses a belt anchored in a Child Restraint Anchorage runs a great risk of suffering severe injuries should a collision occur.

pg. 32 Seat belts

Seat Belts



Always fasten the seat belts before you drive or ride.

Two lights will be illuminated for 4- 8 seconds after the starting (ignition) key is turned to the driving position. One light is located in the instrument panel and one in the console between the front seats. A chime will sound at the same time if the driver has not fastened his seat belt. The rear outboard seats are provided with self-retracting inertia-reel belts. The front seats are provided with twin roller belts.

To buckle:

Pull the belt out from both retractors far enough to insert the latch plate into the receptacle (buckle for rear seats), until a distinct snapping sound is heard. The seat belt retractors are normally "unlocked" and you can move freely, provided that the shoulder belt is not pulled out too far. The retractors will lock up as follows:

- if belt is pulled out rapidly
- during braking and acceleration
- if the vehicle is leaning excessively
- when driving in turns.



In order for the seat belt to provide maximum protection in the event of an accident, it must be worn correctly. When wearing remember:

- the belt should not be twisted or turned
- the lap belt must be positioned low (not pressing against the abdomen). Make sure that the shoulder belt is rolled up into its retractor and that the shoulder and lap belts are taut.

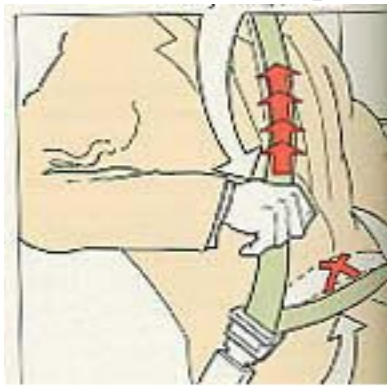

Lap portion of the belt should sit low

Lap portion of the belt should sit low

Before exiting the car, check that the seat belt retracts fully after being unbuckled. If necessary, guide the belt back into the retractor slot.

WARNING!

Any device used to induce slack into the shoulder belt portion of the three-point belt system will have a detrimental effect on the amount of protection available to you in the event of a collision.

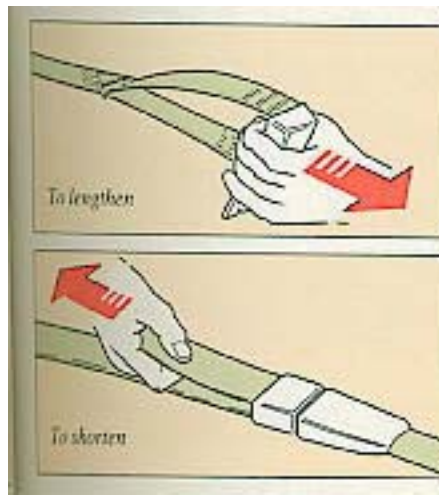

Center-rear belt adjustment

The center-rear seat belt is manually adjustable. It should always be adjusted to fit snugly across the lap.

To unfasten

Depress red push button in receptacle (buckle) and let the belts rewind into their retractors.

Maintenance

Check periodically that the anchor bolts are secure and that the belts are in good condition. Use water and a mild detergent for cleaning. Check seat belt mechanism function as follows: Attach the seat belt. Pull rapidly on the strap.

In the above check you should not be able to null the belt out.

WARNING!

Never use a seat belt for more than one occupant.

Never wear the shoulder portion of the belt under the arm or otherwise out of position.

Such use could cause injury in event of accident.

As the seat belts lose much of their strength when exposed to violent stretching, they should be replaced after any collision, even though they may appear to be undamaged.

Never repair the belt on your own, but have this done by an authorized Volvo dealer only.



During pregnancy

Pregnant women should always wear seat belts. Remember that the belt should always be positioned in such a way as to avoid any possible pressure on the abdomen. The lap portion of the belt should be located low, as shown in the above illustration.

NOTE: Legislation in your state or province may mandate seat belt usage.

pg. 34 Volvo SRS



As an enhancement to the three-point seatbelt system, certain models are equipped with a Supplemental Restraint System (SRS). The Volvo SRS consists of a driver's side airbag with a driver's side knee bolster. The system is designed to supplement the protection provided by the three-point seatbelt system.

The interior of an SRS-equipped Volvo looks very much the same as any other. The only indications of the system's presence are the "SRS" embossed on the steering wheel pad, and the knee bolster beneath the steering column.

The airbag is folded and located in the center of the steering wheel. It is released only during a frontal or front-angular collision in which the forces sustained by the car are equivalent to an impact into an immovable barrier at a speed of approximately 12 mph (19 kph) or greater.

WARNING!

As its name implies, SRS is designed to be a SUPPLEMENT to - not a replacement for - the three-point belt system. The airbag is not designed to be released in the event of a side or rear-end collision, or during a rollover situation. For maximum protection, wear seat belts at all times.



The airbag system includes a gas generator (1), surrounded by the airbag itself (2). In the event of a frontal or front-angular collision equivalent to impacting a rigid barrier at 12 mph (19 kph) or greater, the sensor (3) activates the gas generator, causing the airbag to be inflated with harmless nitrogen gas. As the movement of the driver compresses the airbag, some of the gas is expelled at a controlled rate to provide better cushioning.

The entire process, including inflation and deflation of the airbag, takes approximately two-tenths of a second.

WARNING!

When installing any accessories, make sure that the SRS system is not damaged. Do not attempt to service any component of the SRS yourself. Attempting to do so may result in serious personal injury. If a problem arises, take your car to the nearest authorized Volvo Dealer for inspection as soon as possible.

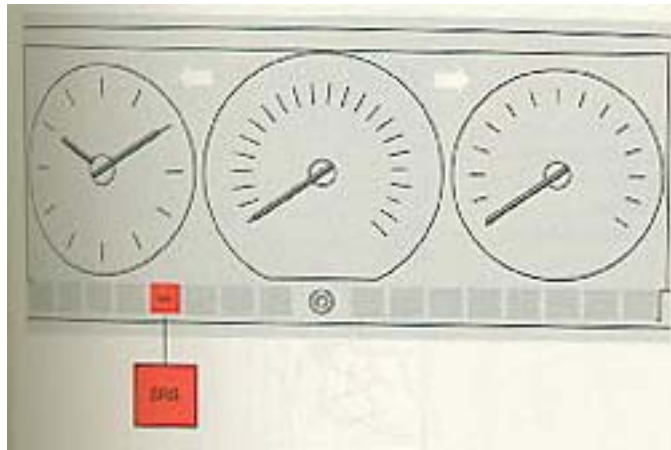

A self-diagnostic system incorporated in the sensor monitors the SRS. If a fault is detected, the "SRS" warning light will illuminate. The light is included in the warning/indicator light cluster in the instrument panel. Normally, the SRS warning light will be illuminated along with the other warning/indicator lights when the ignition key is turned to the ON position (position II), and go out after the engine has been started. Check that this light is functioning properly every time the car is started.

The following items are monitored by the diagnostic system:

- Sensor unit electronics integrity
- Reserve energy supply
- Diagnostic output service
- System voltage
- Integrity of system connectors
- Mercury switch closure
- Gas generator ignitor

WARNING!

If the SRS warning light stays on after the engine has started, or if it comes on while you are driving, drive the car to the nearest authorized Volvo Dealer for inspection as soon as possible.

There is no maintenance to perform on the SRS yourself. The only periodic maintenance recommended on the SRS is that the air bag module and the sensor unit should be replaced every ten years and that the other components in the system (wiring, connectors, etc.) should also be inspected at this time. This service must be performed by an authorized Volvo dealer.



Should you have any questions about the SRS system, please contact your authorized Volvo dealer or the Consumer Affairs Department: In the U.S.A.:

Volvo Cars of North America
One Volvo Drive,
Rockleigh, New Jersey 07647
201-767-4737

In Canada:
Volvo Canada Ltd.
175 Gordon Baker Road
Willowdale, Ontario M2H 2N7
416-493-3700

pg. 36 Doors and locks

Door locks

The vehicle is equipped with a central door-locking system. This means the lock on the driver's door controls the locks on the other doors (including the trunk or tailgate) automatically.

If the driver's door is locked or unlocked from the outside using the key, the other doors will be locked or unlocked automatically.

To lock/unlock the car by using the lock button on the inside of the driver's door, push/pull to lock/unlock all the doors. Check the action of the buttons on the other doors to verify their correct function (lock/unlock). The driver's door can be locked only by using the key when outside the vehicle.

WARNING!

The lock buttons should not be in the down position during driving. In case of an accident, this may hinder rapid access to the occupants of the vehicle.

Also see information on "child safety locks" on next page.



To avoid battery drain

The interior light and the warning lights in the rear of the doors come on when a door is opened. To avoid battery drain when the doors are opened for prolonged periods, these lights can be switched off by pushing in and turning the door light switches slightly clockwise. When the door is closed the switch will return to its normal position.

pg. 37 Child safety locks, Trunk lid (sedan)

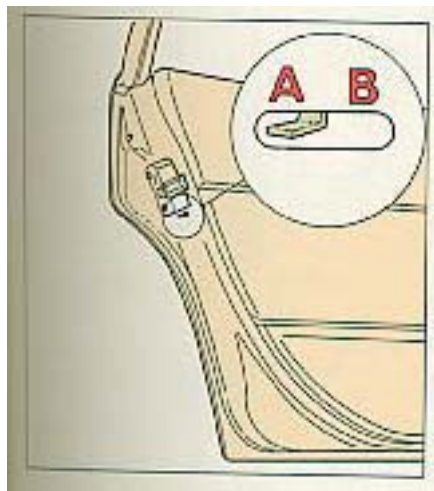

Child safety Locks

The levers are located on the rear door jambs.

A The door lock functions normally.

B The door cannot be opened from the inside. Normal operation from outside.

WARNING!

Remember, in the event of an accident, the rear seat passengers cannot open the doors from the inside with the levers in position B.

Trunk Lid

The trunk lock is incorporated in the central locking system. This means that you can either lock or unlock the trunk by means of the driver's door lock.

You can also operate the trunk lock directly with the owner's key even if the vehicle is centrally locked.



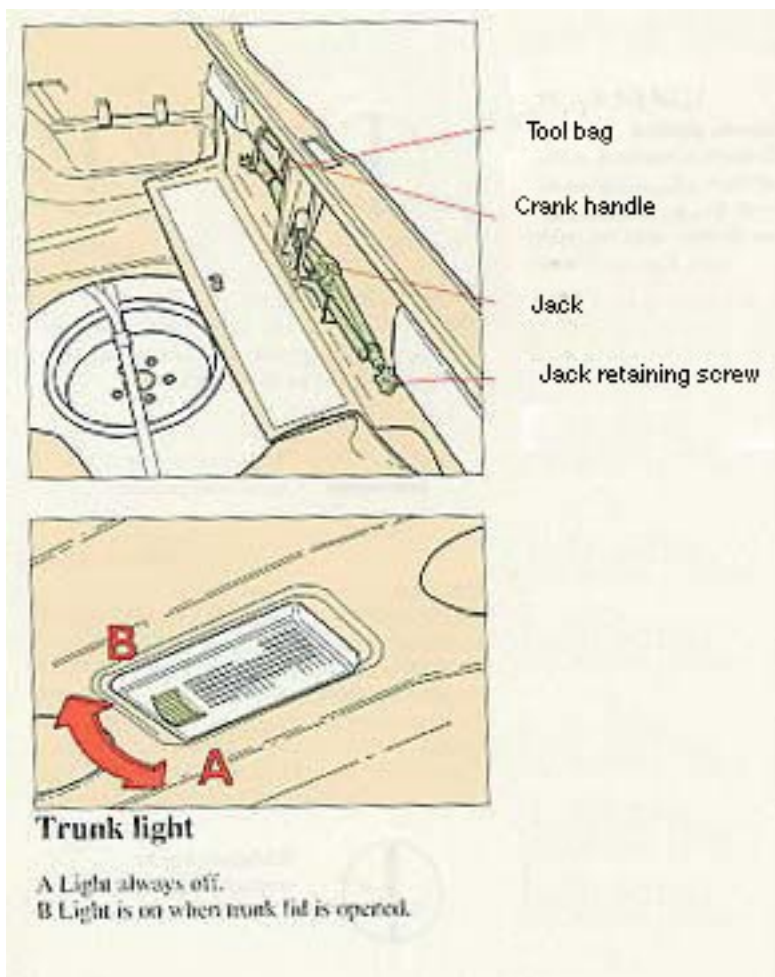

Long load storage

In the panel behind the rear seat is a door which makes it possible to carry long loads such as skis. etc.

WARNING!

Cover sharp edges on load to prevent injury to occupants. Secure load to prevent shifting during sudden stops by wrapping seat belt around armrest as shown.



Protective covers (for skis) should also be used to avoid soiling or tearing the upholstery. Please note that the flap in the rear seat is only intended for light loads such as skis, wood etc.

Max. length of load 6 1/2 ft = 2 m.

Max. weight of load 33 lbs = 15 kg.

WARNING!

Always turn engine off and apply parking brake when loading or unloading the vehicle. Place automatic transmission gear selector in P (PARK) to help prevent inadvertent movement of the selector.

pg. 39 Hood, Engine compartment light

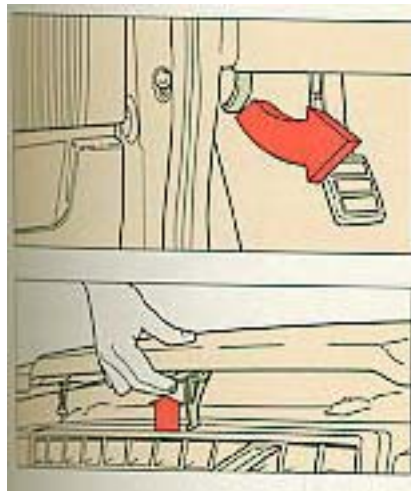

To open the hood

Pull the release handle. It is located under the left side of the dash.

Lift the hood slightly, insert a hand under the center line of the hood and depress the safety-catch handle.

Open the hood.

Check that the hood locks properly when closed.

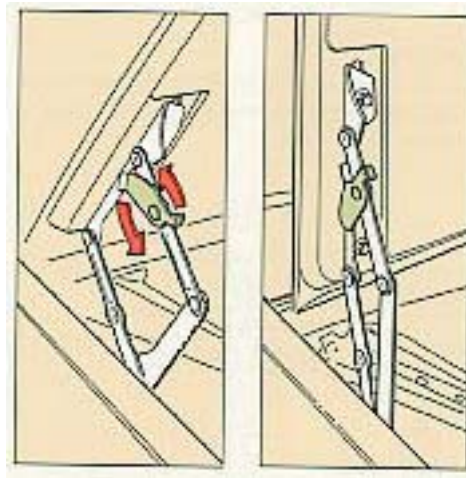

The normal opening angle for the hood is approximately 55° . By turning the catches or the hinges as illustrated, the hood can be opened to the vertical position. The catches will return to their normal positions when the hood is closed.

Take care in low-roof garages!

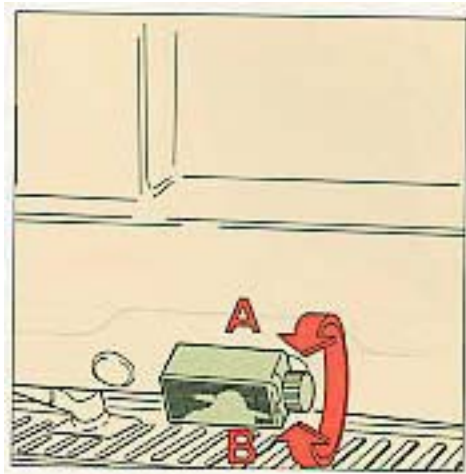

Engine compartment light

A the light is always off

B the light comes on when the hood is opened.

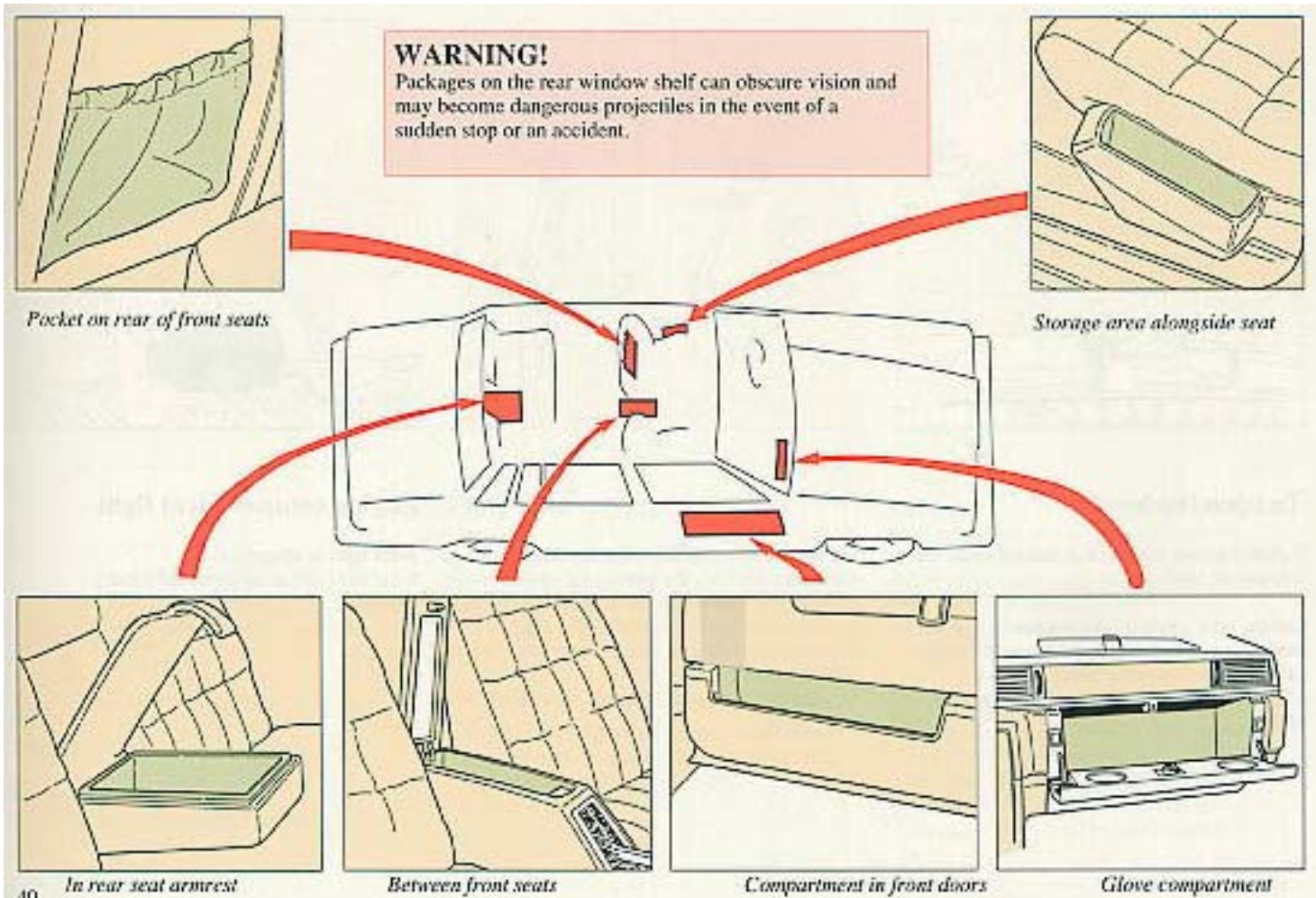

pg. 41 Tailgate, Child safety lock (wagon)

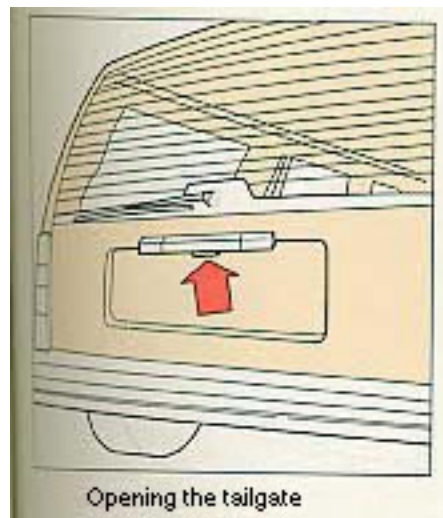

Tailgate

To unlock - turn the key clockwise and allow it to spring back.

To lock - turn the key counter-clockwise and allow it to spring back.

Note: If the vehicle has a central locking system the tailgate will be unlocked and locked at the same

time as the driver's door. the tailgate is opened by pressing up the catch on the handle.



To open the tailgate from the inside of the vehicle, move the handle to the left and push outwards.

WARNING!

Do not drive with trunk lid or tailgate open!

Poisonous exhaust gases may enter via the open trunk lid or tailgate.

If the trunk lid/tailgate must be kept open for any reason, proceed as follows:

- Close the windows
- Set the ventilation system control to  and fan control to its highest setting.



Child safety lock

The tailgate incorporates a safety catch which is located to the side of the lock.

- A the tailgate functions normally
- B the tailgate **cannot** be opened from the **inside**

pg. 42 Concealed storage bins



Concealed storage bins

There are 3 storage bins under the floor of the cargo space; the largest bin can be locked with a key.





Tool box

The tool box can be released by turning the catch.

pg. 43 Folding rear seat (wagon)



Folding rear seat: increasing the cargo space

The rear seat is split 60/40 so that each section can be folded independently.

Note: Straighten from backrests if they are tilted too far to the rear.

Place a hand on the rear of the seat cushion, lift the release lever on the seat cushion, and swing the cushion up and toward the back of the front seats.



Remove head restraints from rear seat. This is done by grasping the restraint and lifting straight up. Move the backrest release lever upwards and fold the backrest forward.

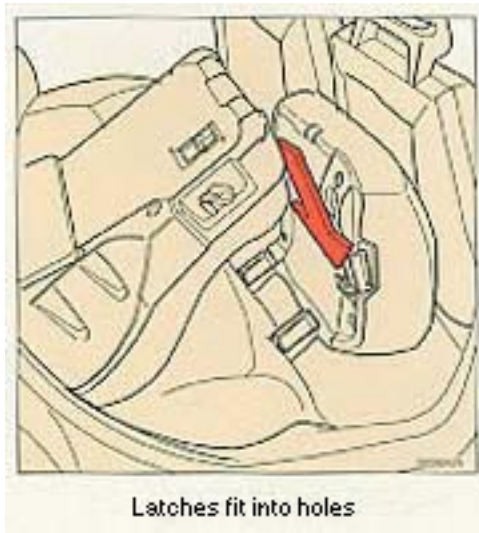

Important: Check that latches under seat cushions engage holes at top edge of backrest. Seat belts must be correctly positioned as seat is returned to normal position.

WARNING!

When the rear seat is folded down, do not place heavy objects against the backs of the front seats. This places a severe strain on the folded down backrest of the rear seat. Cargo must not be stacked higher than the top of seatbacks. This will reduce the possibility of luggage, etc. becoming projectiles during sudden maneuvers, rapid braking or an accident.



Removing seat cushions

The seat cushion can be easily removed to provide a slightly larger cargo storage area. To remove: Lift the seat cushion out of the hinges.

WARNING!

Unless the station wagon is equipped with a genuine Volvo auxiliary cargo-compartment seat, passengers should not ride in this section of the car.

WARNING!

Do not place extremely heavy articles against the front seats, as the backrest which is folded down is then placed under severe strain.

Be sure to secure cargo. Hard and sharp articles could, otherwise, damage the front-seat backrest and/or cause injury to passengers in the event of rapid braking or a collision.



Securing cargo

As a safety precaution, the cargo space is equipped with six eyelets to which straps can be attached to secure luggage. Suitable straps or a cargo net can be purchased from your Volvo dealer.

WARNING!

The eyelets are not to be used as anchorage points for child restraint system tether straps.

pg. 45 Cargo space lighting. Spare tire and jack (wagon)



Cargo space lighting

There is an extra courtesy light at the rear of the cargo space.

- 1 Light comes on when the tailgate is opened
- 2 The light is always OFF
- 3 The light is always ON

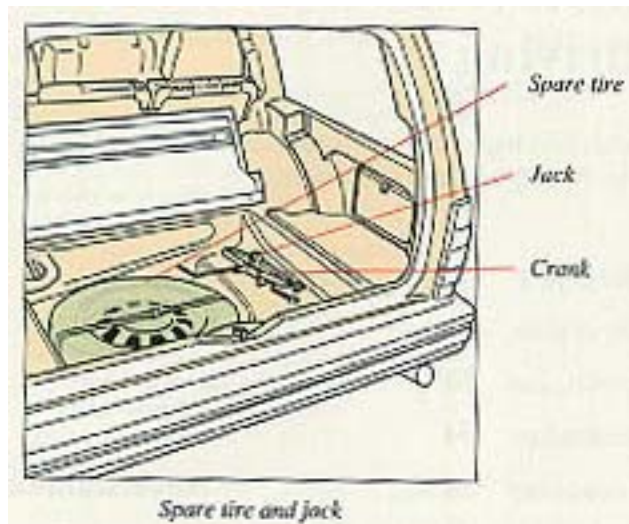

Spare tire and jack

The spare tire and the jack are located beneath the floor mat in the large storage bin. Always secure the spare tire and the jack to prevent them from rattling.



[Contents](#) | [Top of Page](#)

1 9 8 9 VOLVO 740

Starting and driving

pg. 46 Starting and driving. Break-in period

This section on starting and driving contains items such as starting the engine, operating gear selector, towing, trailers.

Fuel requirements, Refueling	47
Starting the engine	48
Transmission	50
Points to remember	54
Driving economy	56
Emergency towing	57
Vehicle towing information	58
Jump starting	59
Catalytic Converter	60
Brakes	61
Towing a trailer	62
Cold weather precautions	63
Before a long distance trip	64
Vehicle storage	65

A new car should be broken-in!

Refrain from utilizing your car's full acceleration during the first 1,200 miles (2,000 km).

Automatic transmission

Do not use "kick-down" during the first 1200 miles (2000 km).

Manual transmission

Do not exceed following speeds:*

Gear	First 600 miles(1,000 km)		600-1,200 miles(1,000-2,000 km)	
	mph	km/h	mph	km/h
first	18	30	25	40
second	30	50	45	70
third	50	80	60	100
fourth	70	110	80	130
overdrive	80	130	90	150

*These are the maximum speeds recommended by the factory. Note that legislation in different countries and states can stipulate maximum speeds other than those given here.

pg. 47 Fuel requirements, Refueling

Unleaded Fuel

Each Volvo has a catalytic converter and must use only unleaded gasoline (as specified on the instrument panel and by a label near the filler inlet). US and Canadian regulations require that pumps delivering unleaded gasoline be labeled "UNLEADED". Only these pumps have nozzles which fit your car's filler inlet. It is unlawful to dispense leaded fuel into a vehicle labeled "unleaded gasoline only". Leaded gasoline damages the catalytic converter and the oxygen sensor system. Repeated use of leaded gasoline will lessen the effectiveness of the emission control system and could result in loss of emission warranty coverage. State and local vehicle inspection programs will make detection of misfueling easier, possibly resulting in emission test failure for misfueled vehicles.

Octane Rating

"Volvo engines require unleaded gasoline with an (R+M)/2 octane rating (also called the Anti-Knock Index, or AKI) of 87 or higher. This is generally equivalent to a Research Octane Number (RON) of 91 or higher. For improved performance, we recommend the use of premium unleaded gasoline (AKI of 91 or higher, RON of 95 or higher)"

Gasoline Containing Alcohol

Some fuel suppliers sell gasoline containing alcohol without advertising the presence of alcohol. If you are not sure whether there is alcohol in the gasoline you buy, check with the service station operator. Blends of unleaded gasoline and ethanol (ethyl alcohol, grain alcohol), sometimes called "gasohol", are available in some areas. Gasohol, if used, must contain no more than 10 percent ethanol and must have an (R+M)/2 rating of 87 or higher. If you experience problems with starting, driveability, or fuel economy with gasohol, you should discontinue its use.

Take care not to spill gasoline during refueling. Gasolines containing alcohol can cause damage to painted surfaces, which may not be covered under the New Vehicle Warranty.

CAUTION: Do not use gasolines containing methanol (methyl alcohol, wood alcohol). This practice can result in vehicle performance deterioration and can damage critical parts in the fuel system. Such damage may not be covered under the NEW VEHICLE LIMITED WARRANTY.

Refueling

The fuel tank filler cap is located behind the door on the left rear fender. **Open cap slowly during hot weather conditions.**

When filling, position the cap in the special bracket on the door. After filling the tank, install the cap and turn until a "click" is heard. The fuel tank is designed to hold approximately 21.1 US gal. (80 liters) sedan, 15.8 US gal. (60 liters) wagon, when sufficient volume left over to accommodate possible expansion of the fuel in hot weather. Be aware that the "usable" tank capacity will be somewhat less than the specified maximum. When the fuel level is low, such factors as ambient temperature, the fuel's "vapor pressure" characteristics, and terrain can affect the fuel pumps' ability to supply the engine with an adequate supply of fuel. Therefore, it is advisable to refuel as soon as possible when the needle nears the red zone, or when the fuel warning light (later models) comes on.

Detergent or Injector Cleaning Gasoline

The use of specially formulated gasoline which contains so called "detergent injector cleaning" additives is allowed and recommended by Volvo. The use of these detergent additives in gasoline has been shown to be effective in reducing the build up of certain injector deposits.

pg. 48 Starting the engine, Turbo caution

To start the engine:

1 Fasten seat belt.

WARNING!

Before starting, check that the seat is adjusted properly. Make sure the brake/clutch pedal can be depressed completely. Move the seat closer if necessary.

2 Apply the parking brake, if not already set.

3 Depress the brake pedal Firmly.

4 Place the gear selector lever in neutral/park (position N or P on cars with automatic transmission).

5 Without touching the accelerator pedal turn the ignition key to starting position. Release the key as soon as the engine starts.

Avoid repeated short attempts to start (fuel is injected every time the starter is engaged when engine is cold). Allow the starter to operate for a longer time (but not more than 15 - 20 seconds).

Do not race a cold engine immediately after starting. Oil flow may not reach some lubricating points fast enough to prevent engine damage.

CAUTION: (740 GLE 16 valve) The hydraulic valve lifters can cause a ticking noise directly after start, especially if the car has not been driven for several weeks. While the valves are "ticking", keep engine speed under 3000 r.p.m.

WARNING!

Always open the garage doors fully before starting the engine inside a garage to ensure adequate ventilation. The exhaust gases contain carbon monoxide, which is invisible and odorless but very poisonous.

Engine warm-up - initial driving procedure

Experience shows that engines in vehicles driven short distances are subject to abnormally-rapid wear because the engine never reaches normal operating temperature, It is therefore beneficial to reach normal operating temperature as soon as possible. This is best achieved by driving with a light foot on the accelerator pedal for a few minutes after starting, rather than prolonged idling.

Turbo caution

Never race the engine **immediately after starting**. Oil flow may not reach some lubricating points fast enough to prevent engine damage. Before switching off the engine, let it operate at idle for a short time to allow the spinning of the turbo-compressor's turbine vanes to slow. After hard driving, this idle time should last a couple of minutes, during which the vanes will slow and the compressor will cool down while still receiving lubrication. If the turbine vanes are spinning at high speeds when the engine is switched off, there is a great risk of heat damage and/or turbine seizure due to lack of lubrication.

Do not race the engine just prior to switching off!

pg. 49 Automatic transmission

Starting and stopping a car equipped with automatic transmission

1. Fasten the seat belts.

WARNING!

Before starting, check that the seat is adjusted properly. Make sure the brake/clutch pedal can be depressed completely. Move the seat closer if necessary.

2. Apply the parking brake and press the brake pedal firmly to hold the car (to prevent it from moving when the gear selector is moved).
3. Select position **P** or **N**. (engine cannot be started in any other position.)
4. Start the engine by turning the starting (ignition) key.
5. Select desired gear. The gear engages with a slight delay, especially noticed in R.
Engine should be idling; never accelerate until after you feel the gear is engaged!
Too rapid acceleration immediately after selecting gears will provide harsh engagement and premature transmission wear.
6. Release the brakes and accelerate.

To stop the car, release the accelerator pedal and apply the brakes.

Selecting position N when standing still with engine running for prolonged periods of time will avoid overheating transmission fluid.

The following "Special Tips" apply to cars with automatic transmission

- For steep hills and when driving for prolonged periods at low speeds position 1 should be selected. Avoid, however, repeated changes since this can cause overheating of the transmission oil. For driving on mountain roads with long persistent uphill gradients, select position 2.
- When negotiating long, steep downhill slopes, position 1 should be selected and position 2 for less severe inclines, in order to obtain the best possible engine braking effect.
- Do not hold the car stationary on an incline by using the accelerator pedal; instead, engage the parking brake. This prevents unnecessary heating of the transmission oil.
- When towing, prepare as follows: Disengage the 4th gear (the indicator light on the instrument panel goes on).

WARNING!

Always place gear selector securely in Park, and apply parking brake before leaving vehicle. Never leave car unattended with engine running.



Gear selector positions

- P park
- R reverse
- N neutral
- D drive
- 2 intermediate
- 1 low

P (Park)

Use this position when parked with the engine running or stopped.

Never use P while car is in motion.

The transmission is mechanically-locked when in position P. Also, apply the parking brake when parking on grades.

WARNING!

Never leave the car when the engine is running. If, by mistake, the gear selector is moved from P, the car may start moving.

R (Reverse)

Never engage R while car is moving forward.

N (Neutral)

Neutral position = no gear is engaged.

Use parking brake.

Driving gears

D (Drive)

D is the normal driving position. Upshifts and downshifts of the forward gears occur automatically and

are governed by accelerator pedal position and vehicle speed.

Lock-up

With the gear selector in position D (Drive) the lockup device disengages the torque converter at speeds above approx. 47-56 mph (75-90 km/h). It provides lowered engine speeds and improved mileage. The lockup engagement may be noticed as an extra upshift when accelerating.

pg. 51 Automatic transmission

2 (intermediate position)

Upshifts and downshifts of first two gears (low and intermediate) occur automatically. No upshifts to 3rd or 4th gear occurs. Position 2 may be used to obtain forced downshift to 2nd gear for increased engine braking effect.

1 (low position)

If position 1 is selected when driving at high speeds, 2 is engaged first and 1 when the speed has dropped approx. 30 mph (50 km/h). **No upshift can occur once 1 is engaged.** Use position 1 to select low gear when no upshift is desired, for instance, when entering and descending steep grades.

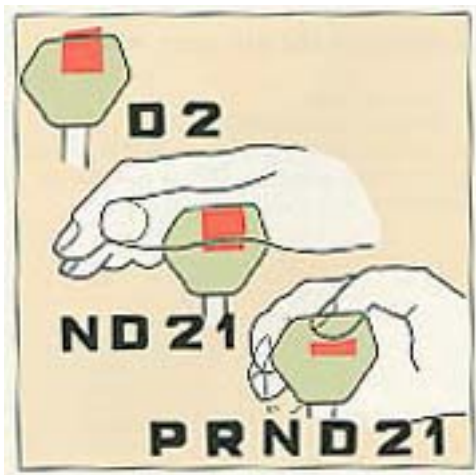

Shift gate

The gear selector can be moved freely between D and 2. Selections of other positions are obtained by depressing the selector knob prior to moving the selector.

Slightly depressing the selector knob allows selection of positions N, D, 2 and 1.



Fully depressing the selector knob allows selection of positions R and P. This is also necessary when initially bringing the selector out of position P.

Fully depressing the selector knob thus permits shifting freely between all positions.

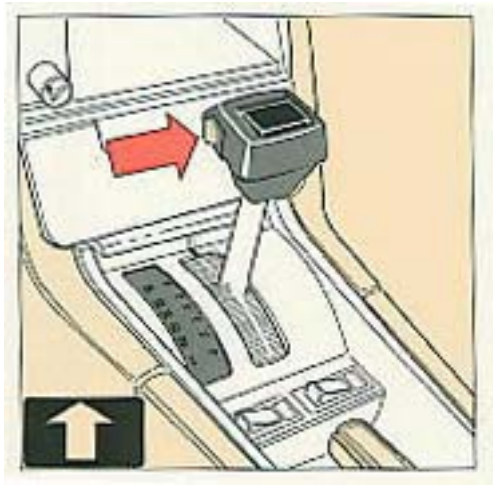
pg. 52 Automatic transmission



4th gear disengagement:

The 4th gear is engaged automatically after the transmission has shifted through 1st, 2nd and 3rd gears at certain speeds and loads. By pressing in the button on the side of the selector lever, the 4th gear can be disengaged, thus providing a three-speed transmission. As a reminder the  light on the dashboard glows. By pressing in the button again, the transmission reverts to four-speed operation and the  light shuts off.

Disengage the 4th gear when:

- towing a trailer
- driving in mountainous regions.

Since using the 4th gear improves fuel economy, it should be used as often as possible in conditions other than those stated above.

Kick-down

Automatic shift to a lower gear is achieved by depressing the throttle pedal fully and briskly.

An up-shift will be achieved when approaching the top speed for a particular gear or by releasing the throttle pedal slightly.

Kick-down can be used for maximum acceleration or when passing at highway speeds below a certain limit.

WARNING!

- Never select P or R while the car is in motion.
- When initially selecting positions D, 3, 2, 1, or R, your foot should press firmly on the brake pedal to ensure that the car is standing still with the engine idling.
- The gear selector should not be downshifted to 2 or 1 at speeds above 75 mph (125 km/h).*

*Always observe local speed limits!

pg. 53 Manual transmission + overdrive

**Gear lever**

Depress the clutch fully when shifting gears, and when engaging/disengaging overdrive (5th gear). Remove foot from the clutch pedal after shifting.

Overdrive (5th gear)

The overdrive can be engaged in 4th gear only the overdrive is engaged/disengaged by depressing the switch on top of the gear shift lever.

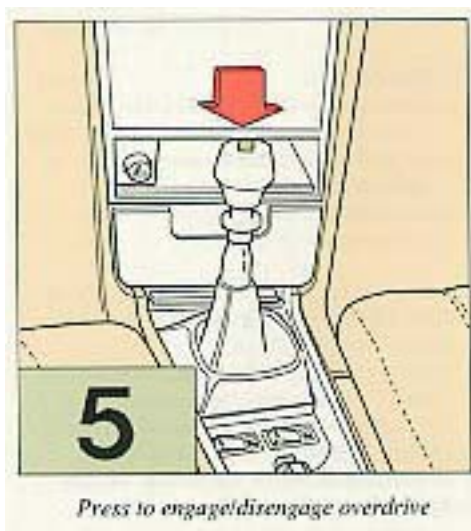

The overdrive is automatically disengaged when downshifting from 4th gear, but you should always disengage the overdrive manually before downshifting.

To improve mileage it is recommended to use the overdrive as much as possible at speeds above 45 mph (70 km/h).

The green control light "5" on the dashboard lights when the overdrive is engaged. See "Shift indicator

light" section for more information on economical use of the manual transmission.

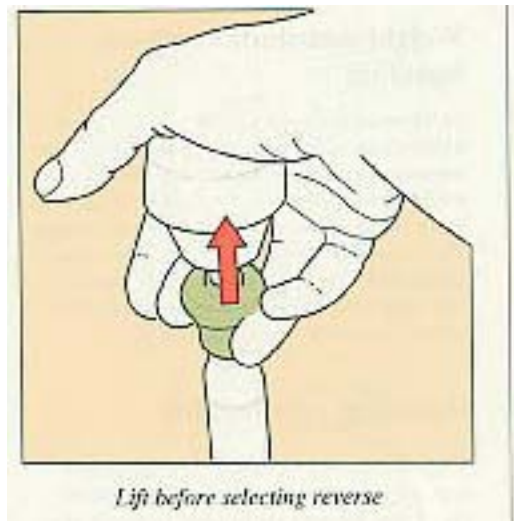

Reverse gear

The detent collar on the gear lever must be lifted prior to engaging reverse gear. This prevents unintentional selection of the gear.

pg. 54 Points to remember

Weight distribution affects handling

At the specified curb weight your car has a tendency to understeer, which means that the steering wheel has to be turned more than might seem appropriate for the curvature of a bend. This ensures good stability and reduces the risk of rear wheel skid. Remember that these properties can alter with the vehicle load. The heavier the load in the trunk, the less the tendency to understeer.

Handling, roadholding

Vehicle load, tire design, and inflation pressure, all affect vehicle handling. Therefore, check that the tires are inflated to the recommended pressure according to the vehicle load. See "Tire pressure" section. Loads should be distributed so that capacity weight or maximum permissible axle loads are not exceeded.

WARNING!

It is recommended that tires of the same make and dimensions be used on all four wheels. Do not use bias ply tires as this will adversely alter vehicle handling characteristics.

WARNING!

An extra mat on the driver's floor may cause the accelerator pedal to catch. Check that the movement of the accelerator pedal is not impeded

CAUTION: Driving through standing water

Drive slowly and carefully if going through standing water (i.e. flooded roadways, etc.). Damage to engine could result if excess water is ingested through the air intake system. **Never drive the vehicle in water deeper than 1 foot (300 mm).**

WARNING!

Do not drive with trunk lid or tailgate open! Poisonous exhaust gases may enter via the open trunk lid or tailgate. If the trunk lid/tailgate must be kept open for any reason, proceed as follows:

- Close the windows.
- Set the ventilation system control to  and fan control to its highest setting.

Roof racks (removable and permanent)

Roof racks are available as Volvo accessories. Observe the following points when in use:

- Avoid single-point loads. Distribute the load evenly.
- Place heavier cargo at the bottom of load.
- Observe that center of gravity and handling are influenced by load weight.
- Increasing load size increases wind resistance and, thus, adversely affects fuel economy.
- Anchor the cargo correctly with a cord.
- Drive carefully. Avoid rapid starts, fast cornering and hard braking.
- Max. roof load is 220 lbs (100 kg) for removable rack mounted on drip rails.
- Max. roof load is 70 lbs (30 kg) for permanent rack mounted directly on roof.

pg. 55 Points to remember

Cooling system

The risk for overheating is greatest, especially in hot weather, when:

towing a trailer up steep inclines for prolonged periods at full throttle and low engine rpm.

idling for prolonged periods while the air conditioning system is in operation.
stopping the engine suddenly after high speed driving (so-called "after-boiling" can occur).

To avoid overheating, the following rules should be followed:

- Reduce speed and downshift when towing a trailer up long, steep inclines. The risk of overheating can be reduced by switching off the air conditioning system for a short time.
- Do not let the engine idle unnecessarily for prolonged periods.
- Do not stop the engine immediately after high-speed driving, but instead, allow the engine to idle for 1/2-1 minute before switching off.

When the risk of overheating is imminent, or in the event of overheating, (the temperature gauge goes repeatedly in or stays continually in, the red section) the following precautions should be taken:

- Switch off the air conditioning system.
- Stop the car and put the gear lever into neutral (position N). **Do not stop the engine!**
- Increase the engine speed to approx. 2000 rpm (twice idling speed).

Electrical system

When replacing the battery or when carrying out work involving the electrical system, the following should be observed:

- A battery connection to the wrong terminal will damage the diodes and electronic equipment. Before connections are made, check the polarity of the battery with a voltmeter.
- If booster batteries are used for starting, they must be properly connected to minimize the risk of the diodes and electronic equipment being damaged. For correct connection, see "Jump starting" section.
- Never disconnect the battery circuit (for example, to replace the battery) while the engine is running, as this will immediately ruin the alternator and electronic equipment. Always make sure that all the battery connections are properly tightened.
- If any electrical/welding work is performed on the vehicle, the ground lead and all the connecting cables of the alternator and electronic equipment must be disconnected and the welder cables placed as near the welding point as possible.

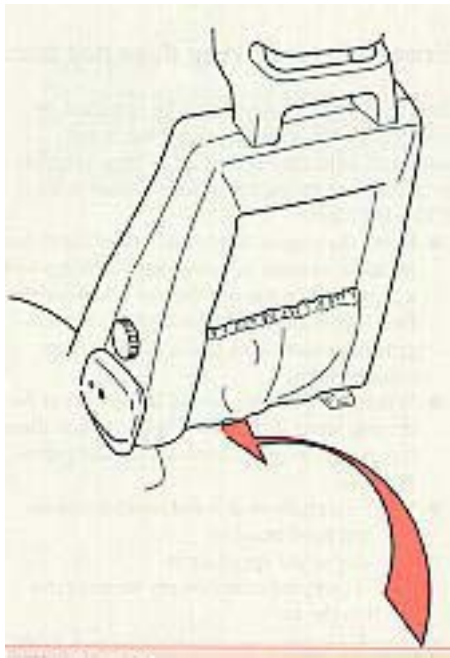
**WARNING!**

The Supplemental Restraint System is grounded under the driver's seat. Do not loosen the two screws grounding the unit. Do not ground other electrical components using these screws or any other points near them. Faults in the system could occur if it is improperly grounded.

pg. 56 Driving economy

Economical driving does not necessarily mean driving slowly

Better driving economy may be obtained by thinking ahead, avoiding rapid starts and stops and adjusting the speed of your vehicle to immediate traffic conditions. Observe the following rules:

- Bring the engine to normal operating temperature as soon as possible by driving with a light foot on the accelerator pedal for the first few minutes of operation. A cold engine uses more fuel and is subject to increased wear.
- Whenever possible, avoid using the car for driving short distances. This does not allow the engine to reach normal operating temperature.
- Drive carefully and avoid rapid acceleration and hard braking.
- Do not exceed speed limit.
- Avoid carrying unnecessary items (extra load) in the car.
- Check tire pressure regularly (check when tires are cold)
- Remove snow tires when threat of snow or ice has ended.
- Note that roof racks, ski racks, etc., increase air resistance and thereby fuel consumption.
- Turbo: try to keep the boost pressure gauge in the black range.
- Utilize overdrive at speeds above approx. 45 mph (70 km/h)

- Avoid using automatic transmission kickdown feature unless necessary.
- On cars with manual transmission, utilize the shift indicator light (S.I.L.). See "Instruments".

Other factors which decrease gas mileage are:

- Worn or dirty spark plugs
- Incorrect spark plug gap
- Dirty air filter
- Incorrect valve clearance
- Dirty engine oil and clogged oil filter
- Dragging brakes
- Incorrect front end alignment
- Low tire pressure

Some of the above mentioned items and others are checked at the standard Maintenance Service intervals.

pg. 57 Emergency towing (pulling of vehicle)

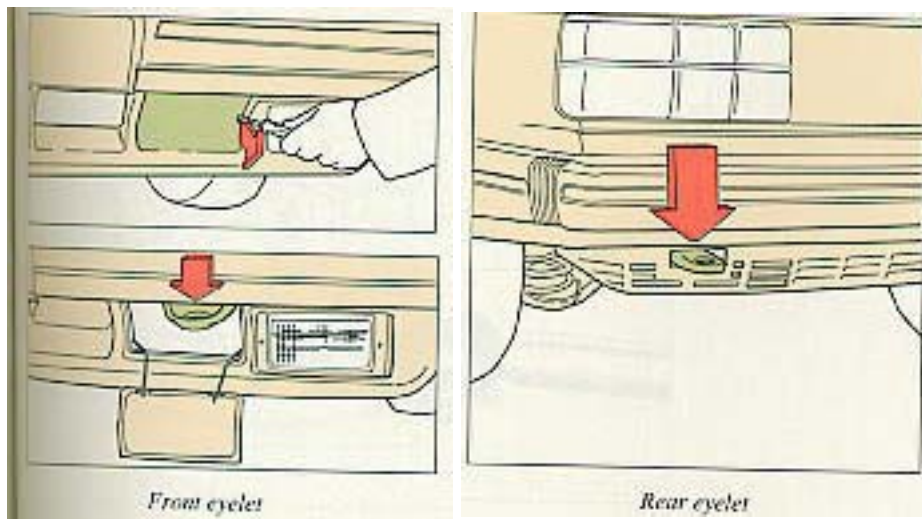

Precautionary steps to Observe when car is in tow:

- Steering must be unlocked.
- **Please check with state and local authorities before attempting this type of towing, as vehicles being towed are subject to regulations regarding maximum towing speed, length and type of towing device, lighting, etc.**
- Remember that power brake and power steering assists will not be available when engine is inoperative. Brake pedal pressure required is 3-4 times above normal and greater steering effort must be exerted.
- Gear selector in position N. Check transmission oil level (see section titled "Transmission oil")
- Maximum speed: 20 mph (30 km/h).

- Maximum distance with rear wheels on ground: 20 miles (30 km).

Cars equipped with automatic transmission /catalytic converters cannot be started by pushing or pulling the car.

CAUTION:

The towing eyelets must not be used for pulling another vehicle out of a ditch or any similar purpose involving severe strain.

pg. 58 Vehicle towing information

Only use wheel lift or flat bed equipment.

CAUTION: Sling-type equipment applied at the front will damage radiator and air conditioning lines. It is equally important not to use sling-type equipment at the rear or apply lifting equipment inside the rear wheels: serious damage to the rear axle may result.

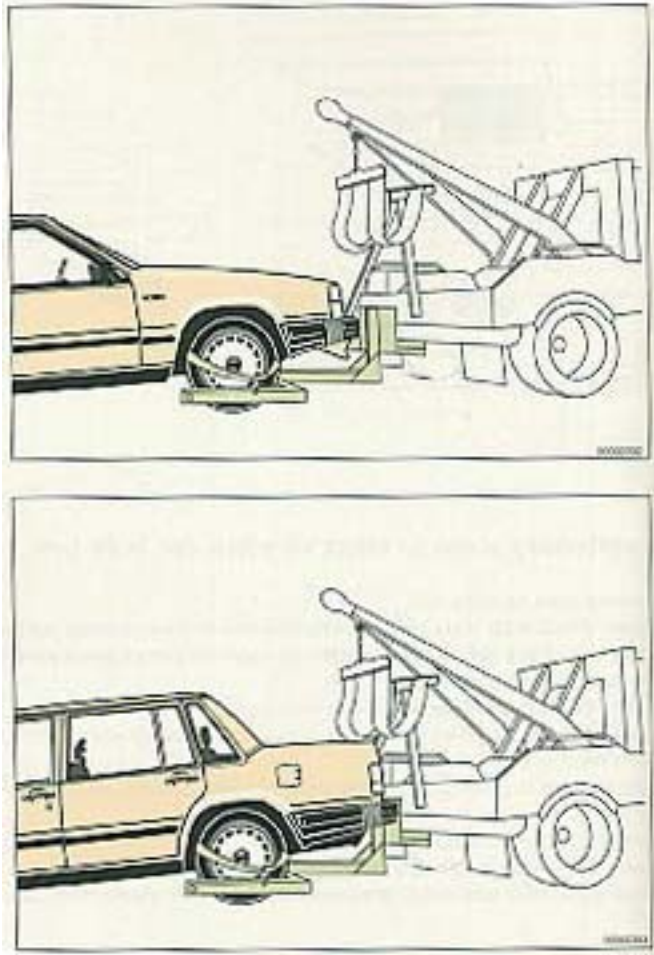

pg. 59 Jump starting

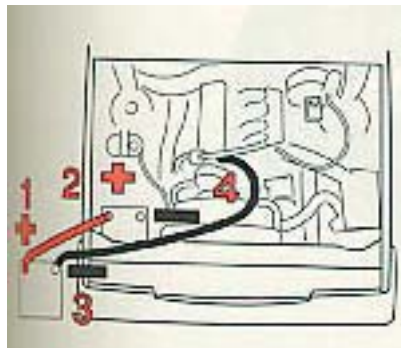

CAUTION:

Improper hook-up of jumper cables or use of other than 12-volt batteries could result in damage to equipment and/or battery.

Check that cars are not touching to prevent premature completion of negative circuit.

Note position of the battery terminals and using jumper cables:

- First connect booster battery positive (+) terminal (1) to car battery positive (+) terminal (2).
- Then connect booster battery negative (-) terminal (3) to a stationary solid metal part on the engine at a point away from the battery (4).

Do not connect booster cable to any part of fuel system or any moving parts. Avoid touching hot manifolds.

- After engine has started, remove first the negative (-) terminal jumper cable. Then remove the positive (+) terminal jumper cable.

WARNING!

To reduce the possibility of explosion, never expose battery to open flame or electric spark. Do not smoke near battery. Batteries generate hydrogen gas which is flammable and explosive.

The battery contains sulfuric acid which can cause serious injury. If the acid comes in contact with eyes, skin or clothes flush thoroughly with water. If eyes are affected, seek medical attention immediately.

pg. 60 Catalytic Converter

Catalytic Converter Cautions

- Keep your engine properly tuned. Certain engine malfunctions, particularly involving the electrical, fuel or ignition systems, may cause unusually high converter temperature. < Br> Do not continue to operate your vehicle if you detect engine misfire, noticeable loss of power or other unusual operating conditions, such as engine overheating or backfires. A properly tuned engine will help avoid malfunctions that could damage the catalytic converter.
- Remember that tampering or unauthorized modifications to the engine or the vehicle may be illegal and can cause catalyst or exhaust system overheating. This include Altering fuel injection settings or components. Adjusting ignition timing beyond specified limits. Altering emission system components or location or removing components. Repeated use of leaded fuel.

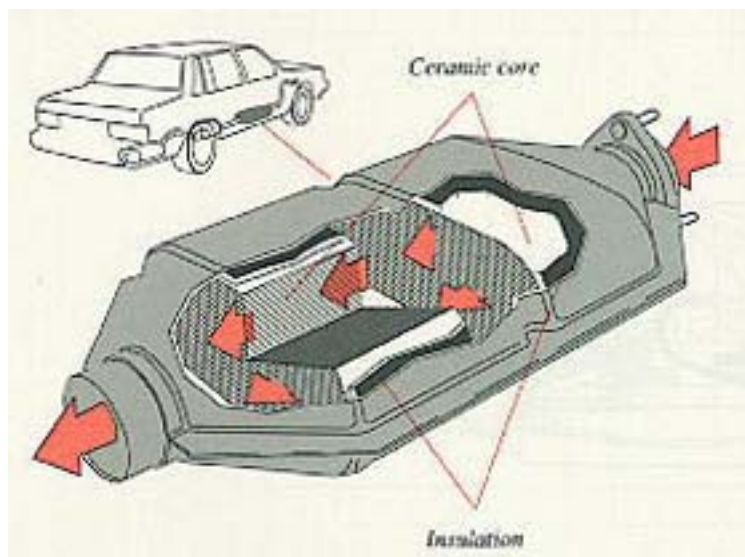

- Do not park your car over combustible materials, such as grass or leaves, which can come into contact with the hot exhaust system and cause such materials to ignite under certain wind and weather conditions.
- Excessive starter cranking, in excess of one minute, with an intermittently-firing or flooded engine, can cause catalyst or exhaust system overheating. This also applies to lengthy pushing or towing of vehicle to start (manual transmission only).

NOTE: Unleaded fuel is required for cars with catalytic converter. A label on the instrument panel and inside fuel tank Filler door will remind owners and filling station attendants of this requirement. Important! It is unlawful to dispense leaded fuel into any vehicle labeled "unleaded gasoline only".

pg. 61 Brake system

If one of the brake circuits should malfunction, the red warning light will come on
(see [page 8](#))

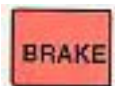

The pedal stroke increases slightly, the pedal feels softer and on cars equipped with ABS, extra pressure is required for normal braking.

On vehicles not equipped with ABS extra pressure is not generally required for normal braking even if there is a malfunction in one of the brake circuits.

If the red warning light comes on while driving or braking: stop immediately, open the hood and check the brake fluid level in the reservoir (see "Brake fluid, power steering" section).

WARNING!

If the fluid level is below the MIN mark in the **entire** reservoir: do not drive. Tow the car to a garage and have the brake system checked/repared.

Moisture on brake discs and brake pads affects braking.

Driving in rain and slush or passing through an automatic car wash can cause water to collect on the brake discs and pads. This will cause a delay in braking effect when the pedal is depressed. To avoid such a delay when the brakes are needed, depress the pedal occasionally when driving through rain, slush, etc. This will remove the water from the brakes. Check that brake application feels normal! This should also be done after washing or starting in very damp weather.

Severe strain on the brake system

The brakes will be subject to severe strain when driving in mountains or hilly areas. The speed is usually low which means that the cooling of the brakes is less efficient than when driving on level roads.

To reduce the strain on the brakes it is advisable not to use the brakes excessively. Instead, shift into a lower gear and let the engine help with the braking. A good rule is to use the same gear downhill as would be used ascending the same grade. For vehicles with automatic transmission use position 2 or, in some cases, 1.

Do not forget that, if you are towing a trailer, the brakes will be subjected to greater load than is normal.

Breaking-in parking brake (hand brake)

To obtain best parking brake performance, the brake linings should be broken-in. Stop 5-7 times from 30 mph (50 km/h), transmission in neutral, applying the parking brake with the release button pressed in during the stop.

The force must not lock the rear wheels. If this happens, release the brake enough to let the wheels rotate. Drive a mile between each stop to cool the brakes. Check for proper parking brake operation.

WARNING!

The brake lights are not illuminated when applying the parking brake. To warn traffic from behind it is therefore advisable to depress the brake pedal slightly to illuminate the brake lights.

If the brake power-assist does not function

The power assist to the brakes functions only when the engine is running. When the car is moving without the engine running the brake pedal pressure required to stop the car is increased by 3-4 times.

The brake pedal feels stiff and hard.

When preparing for trailer hauling, observe the following:

- Use a trailer hitch which meets Federal Safety Standards for rear end collisions (FMVSS 301-75). For trailer weights exceeding 2000 lbs (908 kgs) use only a trailer hitch offered as a Genuine Volvo Accessory. An automatic transmission oil cooler must also be installed, since the automatic transmission is subject to increased load and temperature, certain vehicles are equipped with this extra oil cooler as standard equipment. Consult your Volvo dealer for further information.
- Maximum trailer weight recommended by Volvo is 3,300 lbs (1,500 kgs). Observe legal requirements of the state or province in which the vehicles are registered.

All Volvo models are equipped with energy-absorbing shock-mounted bumpers. Trailer hitch installation should not interfere with the proper operation of this bumper system.

WARNING!

Bumper-attached trailer hitches must not be used on Volvos, nor should safety chains be attached to the bumper. Trailer hitches attaching to the vehicle rear axle must also not be used.

WARNING!

Never connect a trailer's hydraulic brake system directly to the vehicle brake system, nor a trailer's lighting system directly to the vehicle lighting system.

Consult your nearest authorized Volvo dealer for correct installation.

Trailer towing does not normally present any particular problems, but take into consideration:

- Recommended hitch tongue load is 165 lbs (75 kgs) for trailer weights below 2,650 lbs (1,200 kgs) and 143-154 lbs (65-70 kgs) for trailer weights above 2,650 lbs (1,200 kgs). However, the hitch tongue load should not exceed 200 lbs (90 kgs).
- For trailer weights between 2,650-3,300 lbs (1,200-1,500 kgs) a top speed of 50 mph (80 km/h) should never be exceeded.
- Engine and transmission are subject to increased loads. Therefore, engine coolant temperature should be closely watched when driving in hot climates or hilly terrain. Use lower gear and turn off air conditioner if temperature gauge pointer enters the red range.
- Disengage the overdrive on models with automatic transmission.
- Avoid overload and other abusive operation.
- Hauling a trailer affects handling, durability and economy.
- It is necessary to balance trailer brakes with the towing vehicle brakes to provide a safe stop. Check and observe State and Local regulations.
- More frequent vehicle maintenance is required.
- Remove the ball and drawbar assembly when the hitch is not being used.

NOTE: Refer to section entitled "Automatic transmission" for additional trailer hauling tips.

- Increase tire pressure to recommended load pressure. See section "Wheel and tires".

pg. 63 Winter driving

Cold weather precautions

If you wish to check your car before the approach of cold weather, the following advice is worth noting:

- Make sure that the engine coolant contains at least 50 percent antifreeze: that is, 5.0 qts. (4.25 liters) Volvo type C blue-green glycol additive. This gives protection against freezing down to -31 ° F(-35 ° C). See section "Coolant".

- Try to keep the **fuel tank** well filled-this prevents the formation of condensation in the tank.

In addition in extremely cold weather conditions it is worthwhile to add fuel line deicer before refueling.

- Use the correct grade of **engine oil** to avoid difficulties when starting. See section "Engine oil".
- The load placed on **the battery** is greater during the winter since the heater, windshield wipers, lighting etc. are used more often. Moreover, the capacity of the battery decreases as the temperature drops. In very cold weather, a poorly charged battery can freeze and be damaged. It is therefore advisable to check the state of charge more frequently and spray an anti-rust oil on the battery posts.
- The viscosity of the engine oil is important. Oil with low viscosity (thinner oil) improves cold-weather starting as well as decreasing fuel consumption while the engine is warming up. For winter use, 5W-30 oil. particularly the synthetic type is recommended. Be sure to use good quality oil but do not use this cold-weather oil for hard driving or in warm weather.

See section "Engine oil" for more information.

- Use Volvo Teflon lock spray or grease in the locks. They can be purchased from your Volvo dealer.

NOTE: Avoid the use of de-icing sprays as they can cause damage to the locks.

- To prevent the washer reservoir from freezing, add washer solvents containing antifreeze. This is important since dirt is often splashed on the windshield during winter driving, thus requiring frequent use of the washers and wipers. The Volvo washer solvent should be diluted as follows:

Down to 14 °F (-10 °C): 1 part anti-freeze and 4 parts water

Down to 5 °F (-15 °C): 1 part anti-freeze and 3 parts water

Down to 0 °F (-18 °C): 1 part anti-freeze and 2 parts water

Down to -18 °F (-28 °C): 1 part anti-freeze and 1 part water

pg. 64 Long distance trip

Before a long distance trip

It is always worthwhile to have your car checked at a Volvo dealer before driving long distances. Your Dealer will also be able to supply you with bulbs, fuses, spark plugs and wiper blades for your use in the event that problems occur.

A list of all authorized Volvo dealers in the U.S. and Canada is available.

If you prefer to check the car yourself, please note the following:

- Check that engine runs smoothly and that fuel consumption is normal.
- Check engine oil, coolant levels, and for possible fuel leakage.
- Check transmission oil level and rear axle for leakage.
- Check condition of drive belts.
- Check state of charge of battery.
- Examine tires carefully (the spare tire as well), and replace those that are worn. Check tire pressures.
- The brakes, front wheel alignment, and steering gear should be checked by your Volvo dealer only.
- Check all lights, including high beams.
- Reflective warning triangles are a legal requirement in some countries.
- Have a word with your Volvo dealer concerning engine adjustments if you intend to drive in countries where it may be difficult to obtain correct fuel.

City driving

City driving can be a severe driving condition. Low operating speeds, long periods of idling combined with high operating temperatures, air conditioning usage, etc. will make necessary more frequent servicing (at least every third month).

pg. 65 Vehicle storage

If you do not intend to use your car for a long time

the following points may be of use if you do not intend to use your car for a long time (e.g. because of a long holiday, winter, etc.)

- Fill fuel tank to prevent water from condensing inside the tank.
- Wash the car carefully and wax it to protect the paint - don't forget the chromed parts.
- The vehicle should be left in a dry, well ventilated garage.
- Do not apply the hand brake. Block the wheels instead.
- Disconnect the battery's negative (-) cable.
- Lift the wiper arms away from the windshield.
- Increase tire pressure to maximum allowed, i.e. 36 psi.
- Open one of the windows slightly for ventilation.
- Ensure that the coolant contains sufficient anti-freeze to provide protection down to -22°F (-30°C). Volvo anti-freeze also provides resistance against corrosion.
- Remove all valuables and lock the car.
- Check the battery voltage at least every 6 weeks.



[Contents](#) | [Top of Page](#)

1 9 8 9 VOLVO 740

Wheels and tires

pg. 66 Wheels and tires

The handling and riding comfort of the vehicle is dependent on the inflation pressure and the type of tires fitted. Read the following pages carefully.

Special spare tire [66](#)

Changing a
wheel [67](#)

Replacing bulbs [68](#)

General information

Your vehicle is equipped with 6 x 15" wheel rims.

In other words the width of the wheel rim is 6 inches and its diameter 15 inches.

The tire designation is coded as follows:

185 or 195 = tire width in mm.

65 or 60 = tire profile. This is the relationship (in percent) between the section height and width of the tire.

R = radial tires.

15 = suitable intended rim size.

The tires have good road holding characteristics and offer very good handling on dry or wet surfaces. It should be noted however that the tires have been developed to give these features on snow-free surfaces. For optimum road holding on icy or snow covered roads we recommend suitable winter tires.

When replacing tires, be sure that the new tires are the same size designation, type (radial) and preferably from the same manufacturer, on all four wheels. Otherwise there is a risk of altering the car's road-holding and handling characteristics.

NOTE:When storing wheel/tire assemblies (e.g. winter tires and wheels), either stand the assemblies upright, or suspend them off the ground. Laying wheel/tire assemblies their sides for prolonged periods can cause wheel and/or tire damage.

Wear indicator

The tires have a so-called "wear indicator" in the form of a number of narrow strips running across or parallel to the tread. When approx. 1/16" (1.5 mm) is left on the tread, these strips show up and indicate that the tire should be replaced.

Tires with less than 1/16" (1.5 mm) tread have a very poor grip in rain or snow.

When replacing worn tires, it is recommended that the tire be identical in type (radial) and size as the one being replaced. Using a tire of the same make (manufacturer) will prevent alteration of the driving characteristics of the vehicle.

To improve tire economy:

- Maintain correct tire pressure.
- Drive smoothly: avoid fast starts, hard braking and tire screeching.
- Tire wear increases with speed.
- Do not change wheel location unless necessary.
- Correct front wheel alignment is very important.
- Unbalanced wheels impair tire economy and driving comfort.
- Hitting curbs can damage the tires and/or wheels permanently.

Flat spots

All tires become warm during use. After cooling, when the vehicle is parked, the tires have a tendency to distort slightly, forming flat spots. These flat spots can cause vibrations similar to the vibrations caused by imbalanced wheels.

They do, however disappear when the tire warms up. The degree to which flat spots form depends on the type of cord used in the tire.

Remember that in cold weather, it takes longer for the tire to warm up and consequently longer for the flat spot to disappear.

Snow tires, studded tires, snow chains**Tires for winter use:**

Use snow tires fitted to the standard 15" wheel rims (preferably steel). Suitable tire sizes: 185/70 (GL, GLE-16 Valve; on all four wheels) or 195/60 (Turbo: on all four wheels). No rims from other Volvo models can be used on the 740.

Do not mix tires of different design, as this could negatively affect overall tire road grip especially during slippery road conditions!

Studded tires should be run-in 300-600 miles (500-1000 km) during which the car should be driven as smoothly as possible to give the studs the opportunity to seat properly in the tires. The car tires should have the same rotational direction throughout their entire lifetime. In other words, if you wish to rotate

the wheels, make sure that the same wheels are always on the same side of the car.

Tire **chains** can only be used on the rear wheels if the chains do not project too far from the tire and chafe against the brake caliper or other components.

Strap-on emergency chains must not be used since the clearance between the brake caliper and the wheel rim is inadequate.

WARNING!

Special wheel rims for air dams

Only special wheel rims, tested and approved by Volvo, are suitable for use with the air dam installed on the 740.

pg. 68 Wheels and tires

Checking and correcting tire pressure

Check the tire pressure when refueling. The tire pressure should be corrected only when the tires are cold. With warm tires, correct only when the pressure is too low. The tire temperature rises after driving just a few miles.

Vehicle Loading

The tires on your Volvo will perform to specifications at all normal loads when inflated as recommended on the tire information label located on the rear facing side on the right front door. This label lists both tire and vehicle design limits.

Do not load your car beyond the load limits indicated.

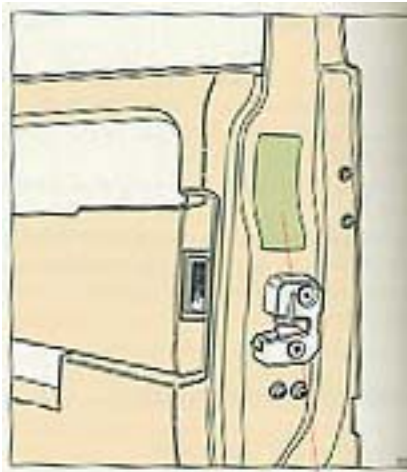

Tire Pressure Label

VEHICLE CAPACITY		WEIGHTS		COLD TIRE PRESSURE	
FRONT	REAR	FRONT	REAR	FRONT	REAR
		2	3	5	
PSI					
RECOMMENDED FOR FULL ECONOMY					
OPTIONAL PRESSURE					
TIRE SIZE		2	1	3	
PSI					
* TIRE BEING INFLATED BY PRESSURE TO ONE PSI ABOVE RECOMMENDED					
SEE	STAKE	MAXIMUM			
SEE OWNER'S MANUAL FOR ADDITIONAL INFORMATION					
VOLVO					

NOTE: This label is a sample.
See label on your car for correct data.

NOTE: This label is a sample. See label on your car for correct data.



[Contents](#) | [Top of Page](#)

1989 VOLVO 740

In case of emergency

pg. 69 In case of emergency

Even if you maintain your car in good running condition, there is always the possibility that something might go wrong and prevent you from driving, such as a punctured tire, blown fuse or bulb....

Special spare tire	70
Changing a wheel	71
Replacing bulbs	73
Replacing fuses	80
Replacing wiper blades	83
Troubleshooting (Service diagnosis)	84

pg. 70 Spare tire

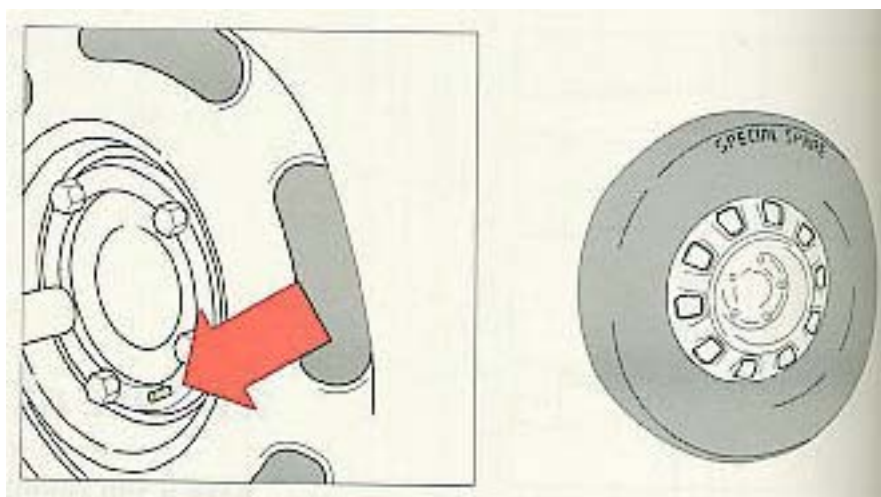

WARNING!

Current legislation prohibits the use of the "Special Spare" tire other than as a temporary replacement for a punctured tire. In other words, it must be replaced as soon as possible by a standard tire. Roadholding, etc.. may be affected with the "Special Spare" in use. Do not, therefore, exceed 50 mph (80 km/h).

Special Spare

The spare tire of your car is what is called a "Special Spare". This is embossed on the tire. See illustration.

Recommended tire pressures (see decal) should be maintained irrespective of which position on the car the Special Spare tire is used on.

In the event of damage to this tire a new one can be purchased from your Volvo dealer.

pg. 71 Wheel changing

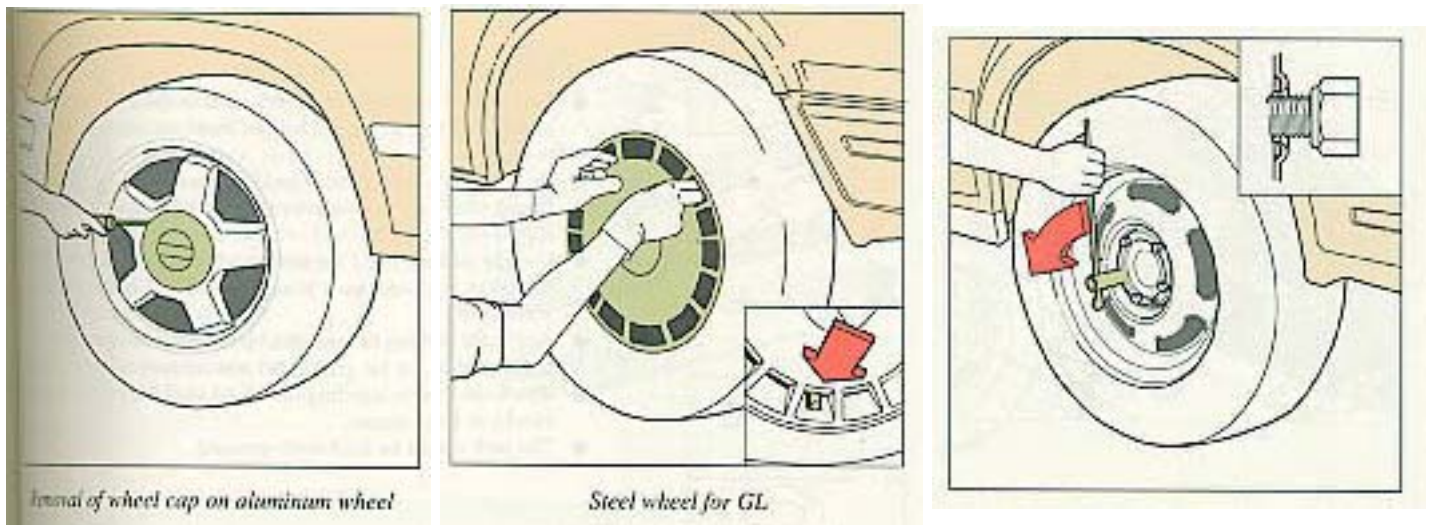
**Changing a wheel**

The spare wheel is located in the trunk, beneath the carpet (sedans), or beneath the rear cargo-area floor (wagons).

Before using the jack, make sure the car is standing on firm, level ground. Apply the parking brake. On models with automatic transmission place the transmission selector lever in position P. On models with manual transmission, place the gear-shift lever in 1st gear or reverse. Block the wheels standing on the ground with wooden blocks or large stones.

- Remove the wheel cap.
- With the car still on the ground, use the box wrench from the tool kit to loosen the wheel nuts 1/2 - 1 turn. Turn the nuts counterclockwise to loosen.

NOTE: To avoid excessive wear and the necessity of rebalancing, mark and reinstall wheels in same location as before removal. To lessen the chance of imbalance, each wheel hub is equipped with a guide stud to ensure that a removed wheel can be reinstalled in its original position (as when changing over to winter tires/wheels).

pg. 72 Wheel changing

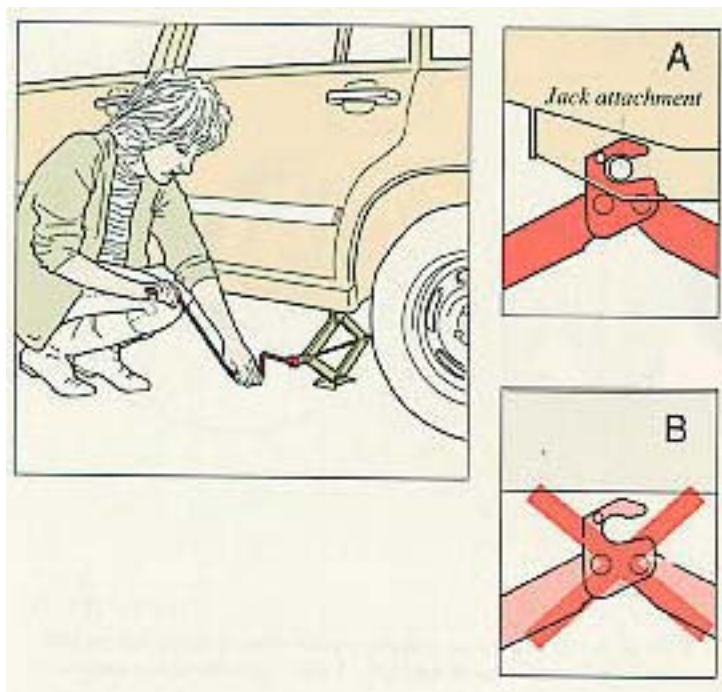

There is a jack attachment adjacent to each wheel location. Hang the jack from the attachment as shown in the illustration and crank while simultaneously guiding the base to the ground. **Before raising the car check that the jack is still correctly positioned in the attachment.**

Now raise the vehicle until the wheel is free from the ground. Unscrew the wheel nuts completely and carefully remove the wheel so as not to damage the thread of the studs.

WARNING!

- The jack's hook must engage the pin in the jack attachment (A). The car's weight must not rest on the jack's hook (B).
- Be sure the jack is on firm and level ground.
- Never allow any part of your body to be extended under a car supported by a jack.
- Use the jack intended for the car when replacing a wheel. For any other job, use stands to support the end of the car being worked on.
- Apply the parking brake, select position P (automatic transmission), or 1st gear or reverse on manual transmission.
- Block the wheels standing on the ground. Use rigid wooded blocks or large stones.
- The jack should be kept well-greased.

Installing the wheel

Clean the contact surfaces on the wheel and hub. Lift the wheel and place it on the hub. Make sure that you align the wheel with the guide stud on the wheel hub prior to installation. Install the wheel nuts clockwise and tighten lightly. The bevelled side of the nuts should face the wheel. Lower the vehicle to the ground and alternately tighten the nuts to 63 ft. lbs. (85 Nm). Install the wheel cap.

Some models have a hub cap that extends to the wheel rim. The valve symbol on the inside of the hub cap should be installed toward the valve. After driving for a short time, a gap of approximately 0.2" (5 mm) will develop between the wheel cover and the rim. This is normal.

pg. 73 Replacing bulbs

NOTE:

The method for replacement of bulbs in the various lighting units is shown on the following pages. Make sure when installing bulbs, that the guide pin on the socket fits into its corresponding recess. When installing Halogen bulbs, do not touch the glass with your fingers. The reason for this is that grease, oil or any other impurities can be carbonized onto the bulb and damage the reflector. Use bulbs of correct type and voltage. Failure to do so could cause the bulb failure warning light to activate.

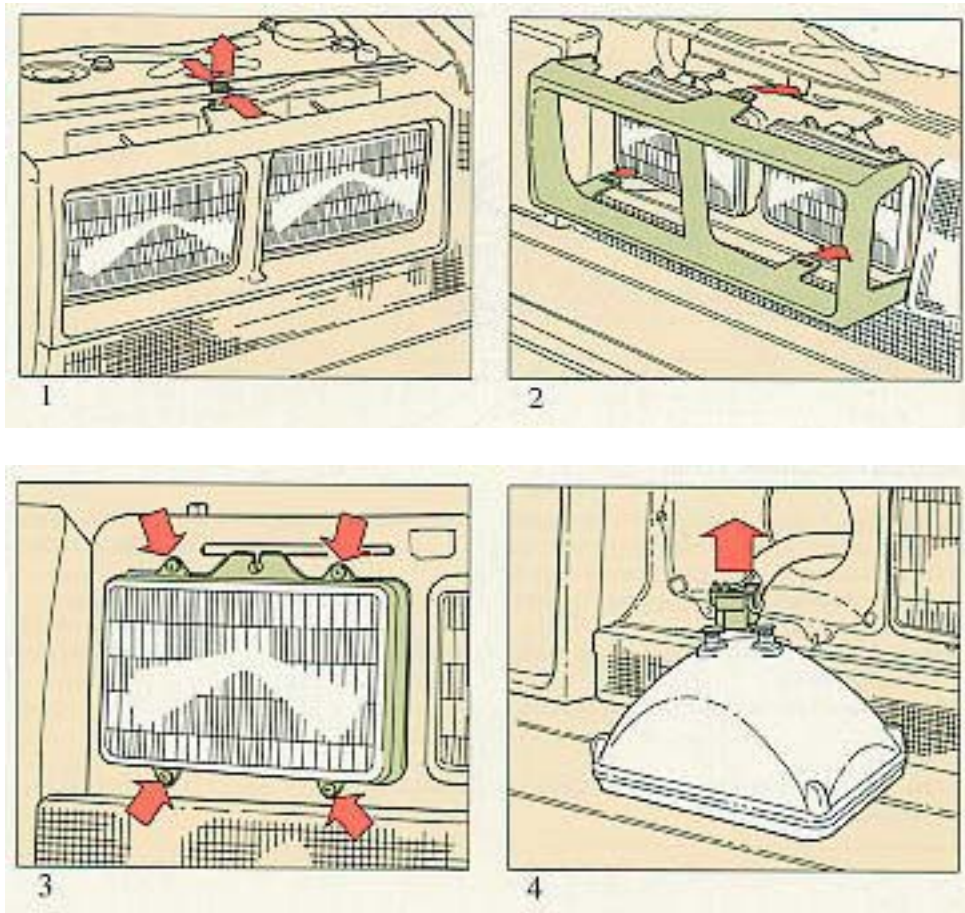

Replacing sealed beam headlamp units

1. Squeeze the clip and pull it upwards.
2. Lift the rim slightly and remove it forwards.
3. Remove Phillips screws and rim. Lift out the headlamp unit.
4. Disconnect the socket contact.

Installation is done by reversing the procedure.

Check headlight alignment.

pg. 74 Replacing bulbs

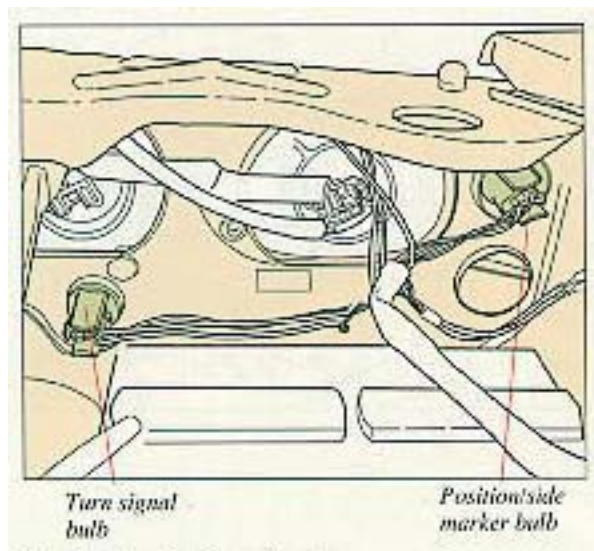

Replacing bulbs, front

Access to the bulbs is obtained from the engine compartment.

- 1 Switch off the lights and starting (ignition) key.
- 2 Do not remove the connector from the bulb holder. Turn the bulb holder slightly counterclockwise and withdraw the bulb holder and bulb.
- 3 Remove the bulb from the holder by pressing in and turning slightly counterclockwise.
- 4 Insert a new bulb and install the bulb holder.

NOTE:

One of the tabs on the bulb holder is slightly wider than the other two.

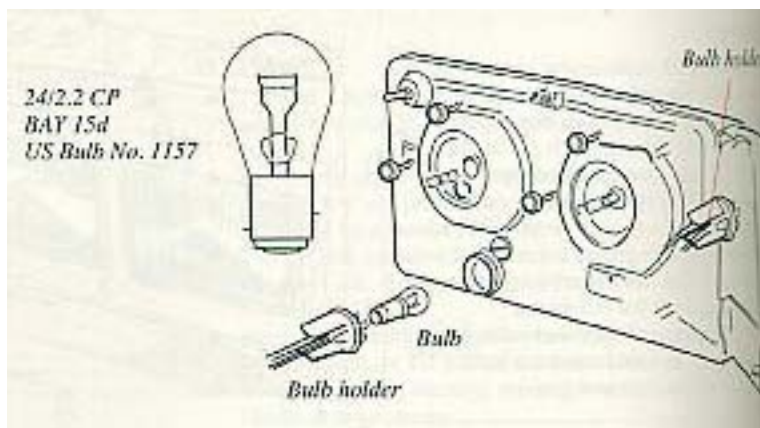

5 Turn the bulb holder clockwise to secure it. Check the bulb function.

NOTE:

It may be necessary to remove the washer fluid reservoir fill tube in order to gain access to the bulb holder.

pg. 75 Replacing bulbs, Sedans

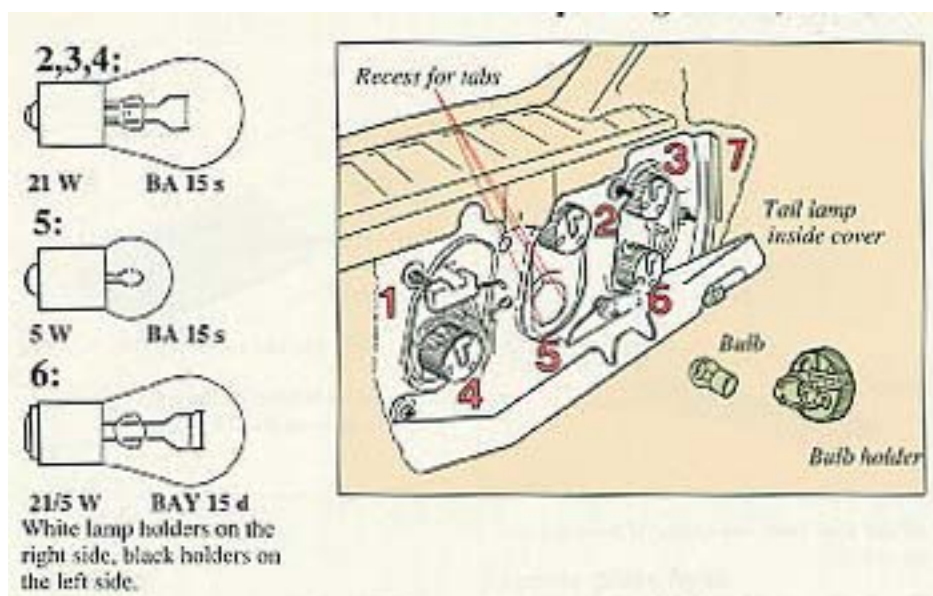

Replacing tail light bulbs (sedan models)

All tail lamp bulbs are replaced from inside of trunk. To avoid confusion, replace the bulbs one at a time.

1. Unscrew and remove tail lamp inside cover. Note that inside cover is hooked at the lower edge.
2. Turn bulb holder (except side marker bulb holder) approx. 3/8" (1 cm) counterclockwise and remove it.
3. Depress bulb in bulb holder, turn it slightly counterclockwise, and remove it.
4. Install a new bulb. Install bulb holder in tail lamp.
5. Turn bulb holder clockwise (except side marker bulb holder). Check that bulb lights. Replace tail

lamp inside cover.

Bulbs	Power CP(W)	Socket	US Bulb No
1 Reflector	-		
2 Back up light	32 (21)	BA 15s	1156
3 Rear turn signal	32 (21)	BA 15s	1156
4 Rear foglamp	32 (21)	BA 15s	1156
5 Tail light	4 (5)	BA 15s	67
6 Tail light/brake light	32/3 (21/5)	BAY 15d	1157
7 Rear side marker light	(4)	BA 9s	

pg. 76 Replacing bulbs Wagons

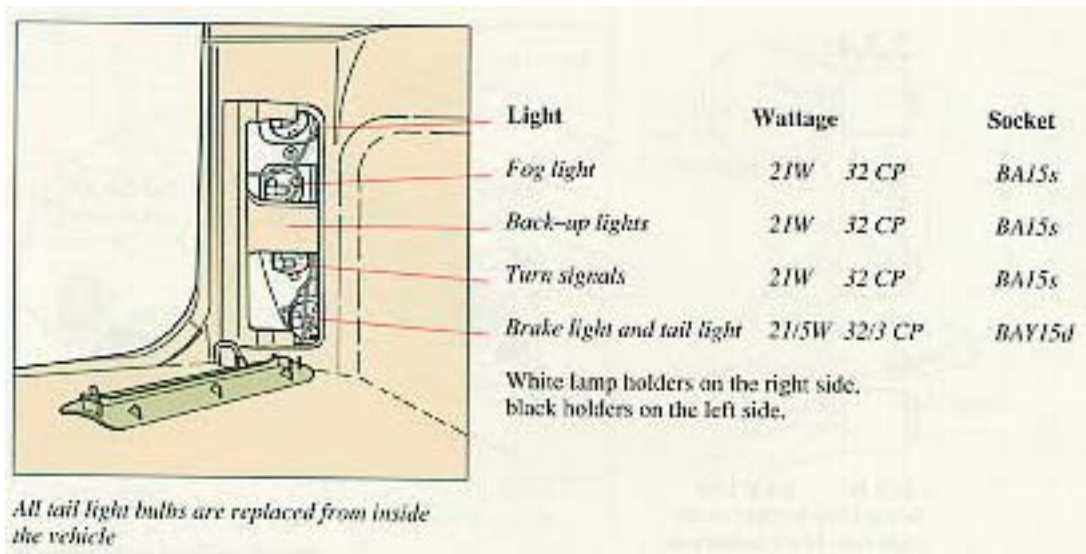

Replacing tail light bulbs (wagon models)

To avoid confusion, replace the bulbs one at a time.

- Turn off the lights
- Remove the cover with a screw driver
- Rotate the bulb holder about 1/2" (1 cm) counterclockwise and remove the holder from the tail light cluster.
- Gently press the bulb into the holder, then rotate the bulb counterclockwise in order to release it.
- Install a new bulb in the holder and replace the bulb holder in the tail light cluster.
- Turn the bulb holder clockwise

- Check that the bulb lights
- Re-install cluster cover

pg. 77 Replacing bulbs

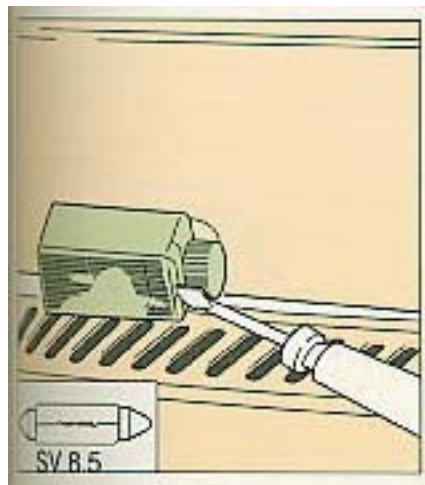

Engine compartment light

Insert a screwdriver and pry off the light assembly. Lift it out to remove.
Replace the bulb.

Bulbs

Engine compartment
light

Power Socket

10 W SV8.5

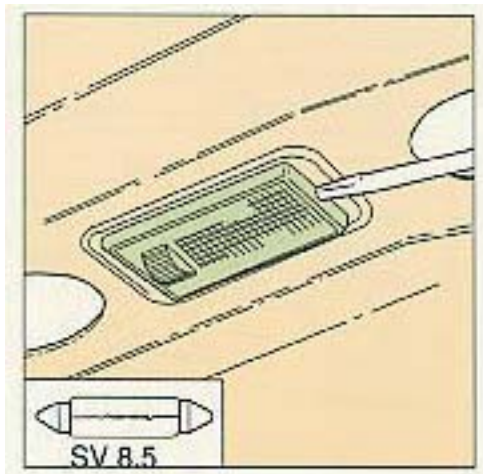

Trunk light

(sedan models)

Depress the catch with a screwdriver and remove the light assembly. Lift it out to remove.
Replace the bulb.

Bulbs **Power Socket**

Trunk
light 10 W SV8.5

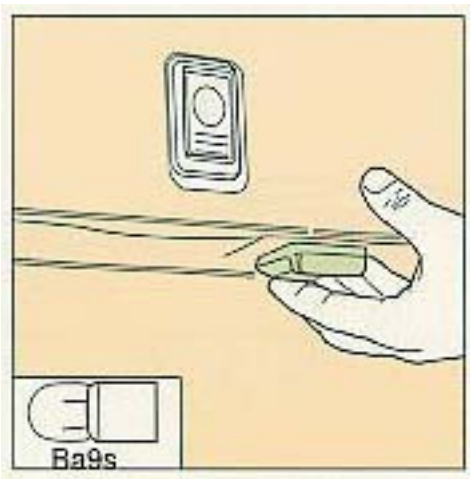

License plate light
(sedan models)

Slide the bulb housing backwards until it is released from the front edge. Pull out the lamp housing and replace the bulb. Insert the front edge of the lamp housing and press up the rear edge by hand.

Bulbs **Power Socket**

License plate
light 4 W Ba9s

pg. 78 Replacing bulbs

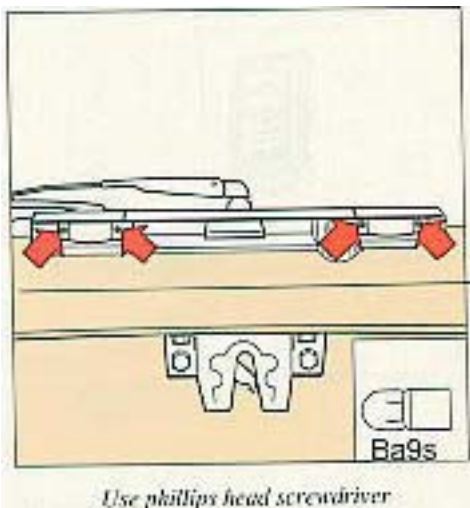

License plate light

(wagon models)

Remove the screws with a Phillips head screwdriver. Remove lamp housing. Depress the bulb and rotate it counterclockwise. Remove the bulb. Install a new bulb and re-install light housing.

Bulbs	Power	Socket
--------------	--------------	---------------

License plate light	4 W	Ba9s
------------------------	-----	------

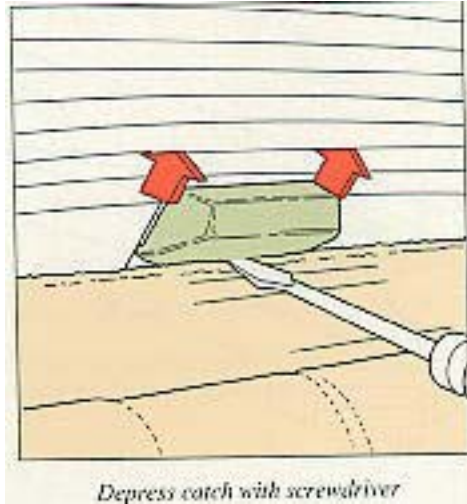
**High-level brake lights**

To remove:

Turn off ignition. Depress catch with a screwdriver.

Sedan models

Pull the cover upwards to remove it.

Wagon models

Grasp the cover with both hands and pull towards you

Bulbs	Power	Socket
--------------	--------------	---------------

High level brake light (US bulb no 1156)	21 W 32 cp	Ba 15s
---	------------	-----------



Depress catches and fit new bulb.

To fit:

Fit the reflector and check that the light works.

Sedan models

Press the cover into position, noting the position of the alignment pin at the top.

Wagon models

Align the catches and press the cover into position.

pg. 79 Replacing bulbs



Interior light and reading lights

Take hold of the front section of the light as shown and pull straight down.

Replace the blown bulb and check operation before reinstalling the bulb housing.

Bulbs **Power Socket**

Interior light 10 W SV8.5

Reading
light

5 W W2.1x9.5d



Door warning lamps

All doors are equipped with red warning lamps. To replace a bulb, insert a screwdriver as shown in picture and gently turn it to remove the lens. Withdraw the bulb, replace it and re-insert the lens.

Bulbs

Door warning
lamps

Power Socket

3 W W2.1x9.5d

pg. 80 Fog lights, Fuses

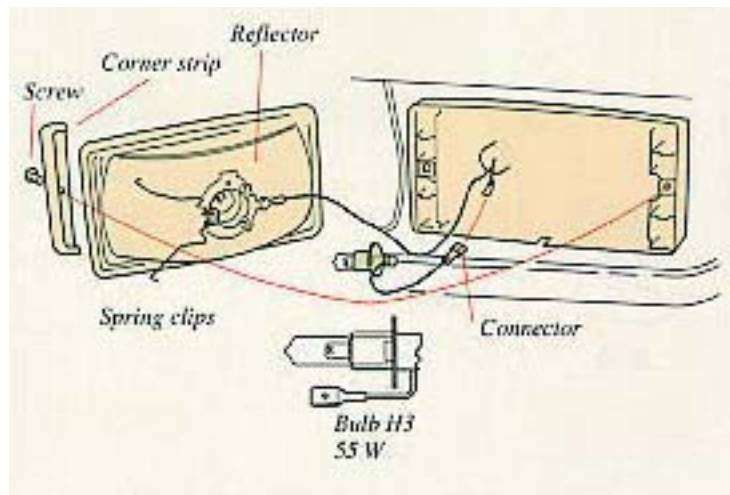

Fog lights (certain models)

Remove the Phillips screws securing the corner strips and pull out the reflector.

Remove the spring clips holding the bulb. Withdraw the connector and install a new bulb. Replace parts in the reverse order. Observe "TOP" on the lens.

NOTE:

Do not touch bulb glass with fingers. Grease or oil can damage reflector when heated.

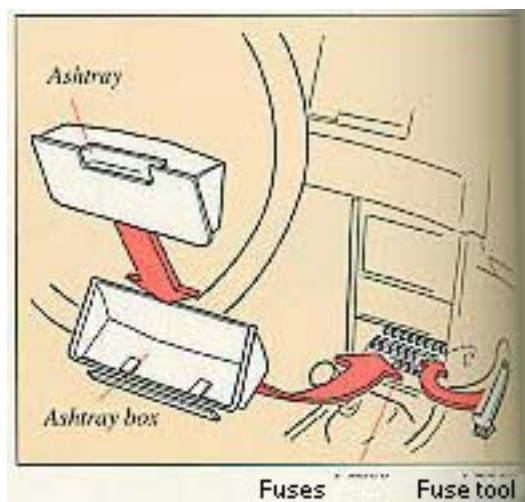
**Fuse replacement**

A blown fuse is indicated by the failure of all the units protected by it, and it is caused by overloading the circuits. The fuses (and relays) are located in the central electrical unit behind the ashtray in the center console.

To obtain access to the central electrical unit: Remove the ashtray. Pull out and depress the tongue. Press up the section marked "electrical fuses-press" and remove the unit.

There are 25 fuses in two rows. See following pages for fuse designations/locations.

pg. 81 Fuses

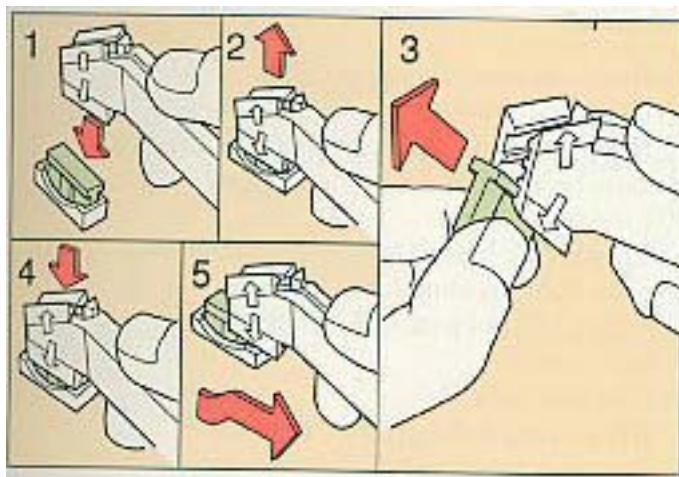

It is necessary to remove the fuses to see if they are blown, see next page for information on fuses and related circuits.

If you find it difficult to obtain access to the fuses, unclip the fuse tool on the right-hand side of the fuse compartment and use it to remove the fuse, see illustration.

- 1 Press the tool onto the fuse.
- 2 Pull the tool and fuse straight up.
- 3 Pull out the fuse from the tool and push in a new fuse in the same way.
- 4 Push in the fuse in the fusebox with the tool.
- 5 Slide the tool out.

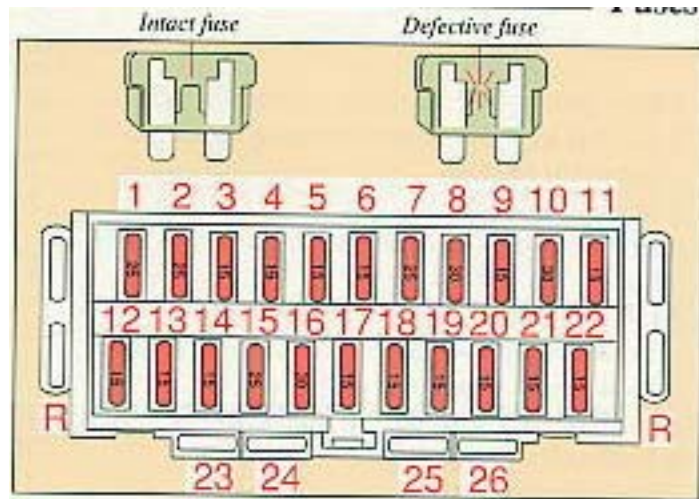

The fuses are removed by pulling them straight out. If they are defective, the metal wire is broken. When fitting a new fuse, be certain to use one with **the same amperage and color** as the one removed (see top of fuse)! Spare fuses are located on each side of the fusebox (1x15A, 1x25A, 1x30A).

pg. 82 Fuses

Location *	Amperage
1 Fuel pump, fuel injection system	25
2 Central locking, hazard warning flasher, headlight flashers	25
3 Fog lights	15
4 Brake lights, shift indicator light, trunk light, antenna, door warning	15
5 Glove compartment light, clock, radio, engine compartment light, interior light, trunk light, antenna, door open warning, power antenna, make-up mirror light	15
6 Heated front seats	30
7 Electric cooling fan	25
8 Electrically operated windows	30
9 Warning light, seat belt, turn signals, air conditioning, heated front seats, electric cooling fan, electrically-operated windows	15
10 Heated rear window Power-operated sunroof	30
11 Tank pump	15

12 Back-up lights, cruise control, overdrive (manual transmission), disengagement of 4th gear on automatic transmission	15
13 Spare	
14 Electrically-operated side view mirrors, cigarette lighter, radio, rear wiper (wagon)	15
15 Horn, windshield wash/wipe	25
16 Heater blower, air conditioning	30
17 High beam (left)	15
18 High beam (right), extra lights	15
19 Low beam (left)	15
20 Low beam (right)	15
21 LH parking lights (front and rear), license plate light, lighting for: ash tray, heater, control panel, switch for heated rear window	15
22 Seat belt light, RH parking lights (front and rear), storage compartment behind parking brake, fog lights	15
23 Spare	
24 Diagnostic socket	
25 Rear fog lights	15
26 Spare	

For more detailed information concerning function and location of relays, fuses, etc., refer to the Volvo Service Manuals. These can be purchased directly using the Service Literature Brochure/Order Form or through your Volvo dealer.

*Some of the equipment/systems listed may be available on certain models only and/or as optional items only.

NOTE: On cars equipped with ABS, the system is protected by an additional 10A fuse located under the instrument panel to the left of the steering wheel.

pg. 83 Replacing wiper blades

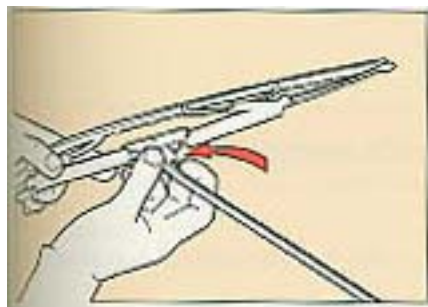

Replacing wiper blades

Lift the wiper arm off the windshield and hold blade at right angles to arm. Pinch the end of the plastic clip located at the back of the arm.

Slide the wiper blade along the arm to release it from the hook.

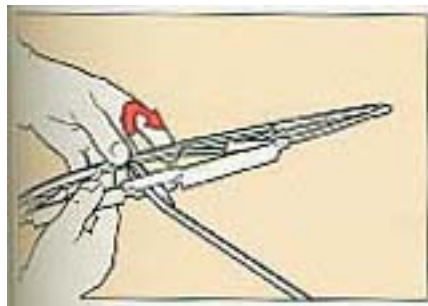

Install new blade, installation is the reverse of removal, and make sure that it is properly attached to the wiper arm.

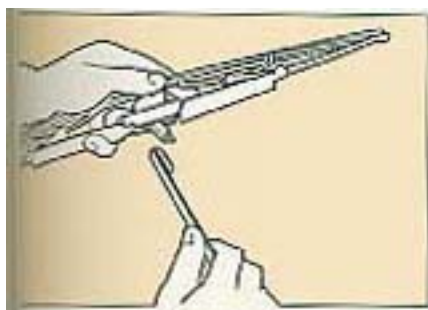

For reasons of safety, you should change the windshield wiper blades as soon as they start to leave marks on the windshield or fail to wipe efficiently and cleanly.

The wiper blades can be cleaned by using a stiff-bristle brush and warm, soapy water.

pg. 84 Service diagnosis

This section contains information which can be of help in the event of a breakdown. Only those faults which can be rectified with the vehicle's tool kit are listed.

The engine does not start or is difficult to start

The instructions for starting the engine have not been followed:

Follow the instructions in section "Starting the engine".

The battery is poorly charged or dead

Start the vehicle by using an auxiliary battery.

Recharge the battery.

Find out why the battery is poorly charged.

Poor contact in the electrical system

Check all leads to spark plugs, coil, distributor, battery and starter motor.

No fuel reaching engine

Check that there is fuel in the tank.

Check that none of the hoses in the fuel system are loose.

Check that the fuses for the fuel pump are not faulty, fuses No. 1 and 11.

Faulty ignition system

Check spark plugs, electrode gap should be 0.028" (0.7 mm), and wipe clean.

Check distributor cap for cracks and wipe clean on inside.

Check that all electric leads in the ignition system are clean and correctly connected.

Misfiring and erratic engine operation

Faulty ignition system

Check spark plugs, electrode gap should be 0.028" (0.7 mm), and wipe clean.

Check distributor cap for cracks and wipe clean on inside.

Check that all electric leads in the ignition system are clean and correctly connected.

Ice in injection system

Park the vehicle in a warm garage and add a fuel line de-icer to the fuel system.

Blocked air Filter/fuel filter

Change filter

pg. 85 Service diagnosis

Tire imbalance or vibration during driving

Wheel imbalance

Have the wheels re-balanced.

Level of oil in power-assisted steering pump too low

Check and fill oil, see section "Power steering fluid".

Engine overheats

Radiator hose cracked or leaking

Check and replace if necessary.

Insufficient coolant

Check and fill coolant, see section "Cooling system"

Fan belt frayed or belt tension incorrect

Replace or adjust tension.

pg. 86 Service diagnosis

Emergency sun roof operation

If, because of an electrical fault (e.g. a blown fuse), it is not possible to operate the sun roof electrically, then it is possible to operate it manually.

First, using a Phillips-head screwdriver, remove the two screws that secure the sun roof motor cover to the headlines. Then using a screwdriver, depress the white plastic clutch pin in the center of the motor screw (see illustration) and turn the screw to close or open the roof as desired.

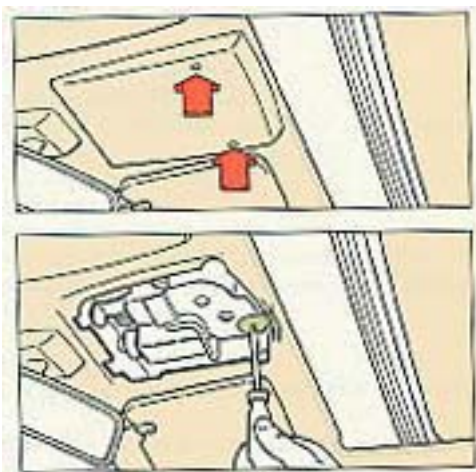

[Contents](#) | [Top of Page](#)

1 9 8 9 VOLVO 740

Car care

pg. 87 Car care

Car care includes not only maintaining the appearance of the car, but also protecting the car exterior from the effects of air pollution, rain and mud.

The rustproofing compound under the car should be checked regularly and, if necessary, damaged areas should be repaired.

The paintwork should also be touched up immediately, if damaged, to prevent rust formation.

Rustproofing	88
Paintwork damage	90
Washing the car	92
Cleaning the upholstery	94

pg. 88 Rustproofing

What causes rust

The two most common causes of rust to your car are:

The accumulation of road dirt and moisture in hard-to-get-at cavities and other areas under the car. The removal of paint and protective coatings on the outside of the car and underneath through damage by stones, gravel or minor accidents.

Several factors influence the speed at which corrosion will occur:

- The length of time various parts of a car stay wet. Parts of the car filled with road dirt and water remain damp for long periods of time even after other parts have dried. Particular attention should be paid to the underside of the car and floor sections inside. The floor sections stay wet because moisture collects and remains under the floor matting. Drain holes located at the bottom of the doors can get clogged with dirt, trapping water inside the door and causing the door to rust through at the bottom.

- Corrosion will be accelerated in areas of higher relative humidity, especially where temperatures often stay above the freezing point and where the atmosphere is affected by industrial pollution, or where salt is used for de-icing the roads. Where parts of the car are covered with road dirt containing road salt, corrosion will be accelerated at lower relative humidity than if the surface were clean.
- Increased temperature will cause an accelerated rate of corrosion of those parts of the car which are not well ventilated to permit quick drying.
- Industrial pollution and the presence of salt will also accelerate the deterioration of paint finishes.

The foregoing identifies the need for every car owner to keep his or her car-particularly the underside-as clean and dry as possible and to repair any minor damage to paintwork and protective coating as soon as possible.

The need is more important in those areas where road salt is used for de-icing, the relative humidity is higher, air pollution is present, and temperatures regularly stay above freezing.

Rustproofing, inspection and touching-up

Your Volvo was carefully and thoroughly rustproofed at the factory. The underbody and wheelhousings were sprayed with a thick, durable rustproofing compound and the beams, internal cavities and end sections were sprayed with a low viscous, penetrating rustproofing agent.

There are two very effective methods of maintaining this protection:

- Keep your car clean. Clean the underbody, wheelhousings and the edges of the fender using water at high pressure.
- Inspect and touch-up the rustproofing if necessary.

The invisible (internal) rustproofing

The invisible rustproofing, used for beams, internal cavities and end sections, should be retreated first after 36 months and, thereafter, every 24 months.

Bear in mind, if good results are to be obtained, these sections must be treated with a fine spray of Volvo-approved rustproofing compound at a workshop with the correct spraying equipment. Consult your local Volvo dealer.

pg. 89 Rustproofing

The visible rustproofing

The visible (external) rustproofing must be inspected by an authorized Volvo dealer at least once a year. If it is necessary to touch-up the rustproofing, this should be done immediately to prevent moisture penetration. Wash and dry the car thoroughly before touching up. Use spray-on or brush-on rustproofing compounds.

There are two different types of rustproofing compounds available:

- a. thin (transparent) for visible parts.
- b. thick, for parts on the underbody and wheel housing which experience most wear.

Parts of the car which may need to be touched up and the recommended rustproofing compound are:

- visible welded seams and panel seams-(thin)
- underbody and wheel housings-(thick)
- door hinges-(thin)
- hood hinges and locks-(thin).

After completion of all work on the vehicle, remove excess rustproofing compound with a cloth soaked in kerosene.

The sheet metal surfaces of the engine compartment are protected by a transparent wax-based rustproofing compound. The compound withstands normal washings without deterioration.

Mineral based solvents will, however, dissolve the compound, especially so if they contain emulsifiers. In such cases the wax protection should be renewed.

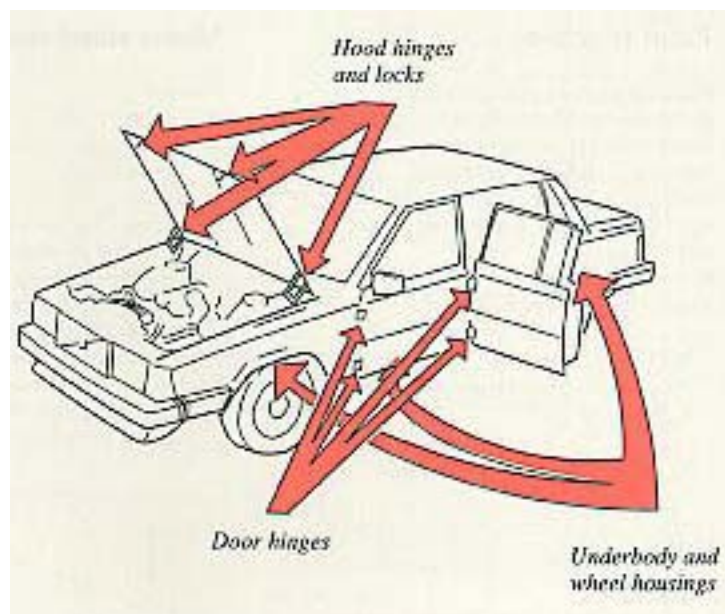

pg. 90 Paint touch-up

Paint touch-up

Paint damage requires immediate attention to avoid rusting. Make a habit of checking the finish regularly; when washing the car for instance. Touch up if necessary.

Paint repairs require special equipment and skill. Contact your Volvo dealer for any extensive damages. Minor scratches can be repaired by using Volvo touch-up paint.

NOTE: When ordering touch-up paint from your Volvo dealer, use the paint code indicated on the model plate. The plate is located on the panel above the right-side head lights.

NOTE: When touching up the car, it should be well cleaned and dry and have a surface temperature above 60 °F (15 °C).

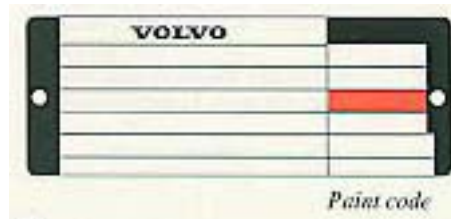

Minor stone chips and scratches

Material:

- Primer - can
- Paint - can or touch-up
- Masking tape
- Brush

If the stone chip has not penetrated down to the metal and an undamaged layer of paint remains, the touch-up paint can be applied as soon as the spot has been cleaned.

If the stone chip has penetrated down to the metal, proceed as follows:

1. Place a strip of masking tape over the damaged surface. Pull the tape off so that any loose flakes of paint adhere to it.

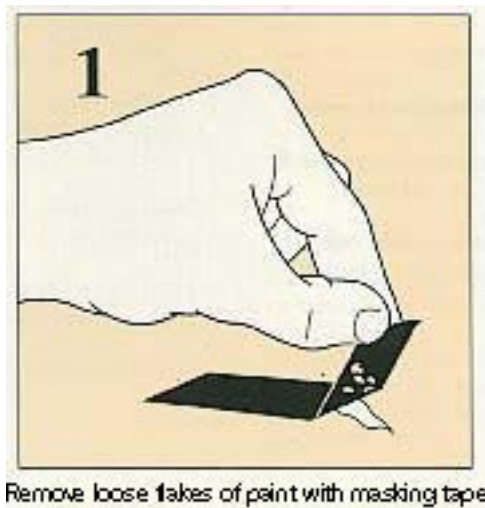

Remove loose flakes of paint with masking tape

- 2 Thoroughly mix the primer and apply it with a small brush.

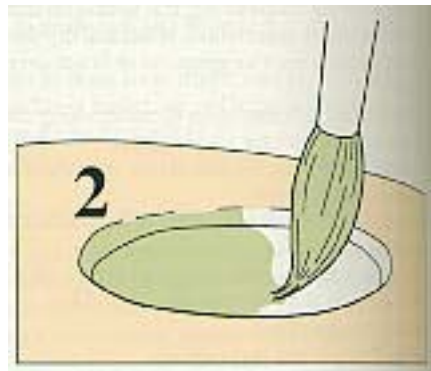

When the primer surface is dry, the paint can be applied using a brush.
Mix the paint thoroughly; apply several thin paint coats and let dry after each application.

pg. 91 Paint touch-up

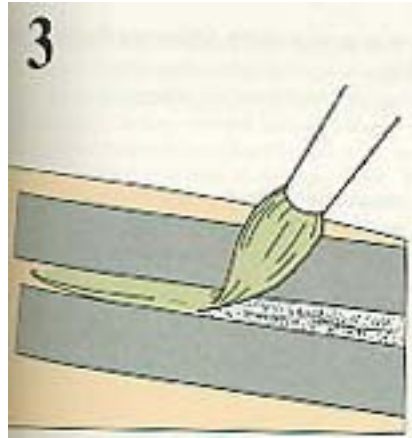

3 If there is a longer scratch, you may want to protect surrounding paint by masking it off.

Touching up damaged paint on fender edges and sills

Material:

- Primer - spray
- Paint - spray
- Masking tape

NOTE: When touching up the car, it should be well cleaned and dry and have a temperature exceeding 60°F (+15°C).

Mask with tape and paper prior to painting larger surfaces. Remove the masking immediately after application of the last paint coat, before the paint starts to dry.

Touching up is as follows:

- Remove paint flakes with masking tape.
- Shake the spray can for at least 1 minute. Spray on the primer. Move the can slowly and evenly back and forth over the spot and about 8-12 in. (20-30 cm) from the surface. Protect the surrounding surfaces with suitable paper.

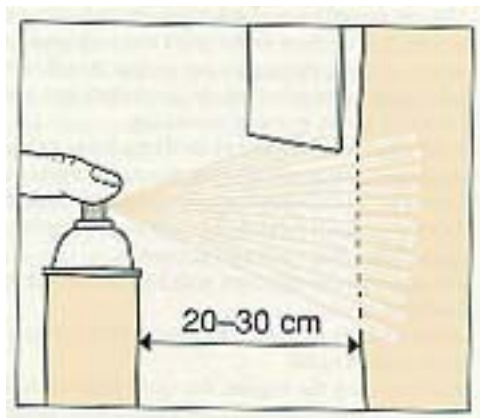
**WARNING!**

Spray painting should be done in a well ventilated and dust-free area.

- When the primer has dried, apply the surface enamel in the same way. Spray on several times and allow the paint to dry a minute or so between each application.

pg. 92 Washing

Washing the car

The car should be washed at regular intervals since dirt, dust, insects and tar spots adhere to the paint and may cause damage.

When washing the car, do not expose it to direct sunlight. Use lukewarm water to soften the dirt before you wash with a sponge, and plenty of water, to avoid scratching.

A detergent can be used to facilitate the softening of dirt and oil. A water-soluble grease solvent may be used in cases of sticky dirt. However, use a wash place equipped with a drainage separator. Dry the car with a clean chamois and remember to clean the drain holes in the doors and rocker panels.

Tar spots can be removed with kerosene or tar remover after the car has been washed.

After washing, lubricate the electrically-operated antenna mast with a cloth soaked in oil.

After washing the engine, the spark plug wells should be blown dry. A stiff-bristle brush and lukewarm soapy water can be used to clean the wiper blades. Frequent cleaning improves visibility considerably.

NOTE: It is particularly important to wash the car frequently in the wintertime to prevent corrosion, when salt has been used on the roads. Also wash off the dirt from the underside (wheel housings, fenders, etc.)

In areas of high industrial pollution more frequent washing is also recommended.

Suitable detergents

Special car washing detergent or household detergent can be used. A suitable mixture is about 2.5 fl. oz. (8.5 cl) of detergent to 2.6 US gal. (10 liters) of warm water. After washing with a detergent the car should be well rinsed with clean water.

Bird droppings

Remove from paintwork as soon as possible. Otherwise the finish may be permanently damaged.

WARNING!

When the car is driven immediately after being washed, apply the brakes a few times in order to remove any moisture from the brake linings.

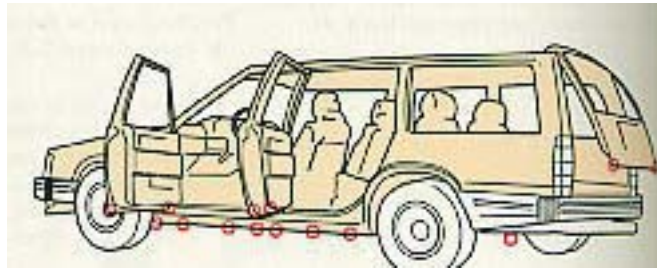

NOTE: When washing the car, remember to remove dirt from the drain holes in the doors and sills.

pg. 93 Automatic car washing, Polishing and waxing, Chromed parts

Automatic washing - simple and quick

An automatic wash is a simple and quick way to clean your car. Keeping the under-body clean is most important, especially in the winter. Some automatic washers do not have facilities for washing the underbody. Before driving into an automatic wash, make sure that side view mirrors, auxiliary lamps, etc., are secure, otherwise there is risk of the machine dislodging them. You should also lower the antenna. We recommend that you do not wash your car in an automatic wash during the first six months (because the paint will not have hardened sufficiently)

Polishing and waxing

Normally, polishing is not required during the first year after delivery, however, waxing may be beneficial.

Before applying polish or wax the car must be washed and dried. Tar spots can be removed with kerosene or tar remover. Difficult spots may require a fine rubbing compound.

After polishing use liquid or paste wax.

Several commercially-available products contain both polish and wax. Waxing alone does not substitute for polishing a dull surface. A wide range of polymer-based car waxes can be purchased today. The waxes are easy to use and produce a long-lasting, high-gloss Finish that protects the bodywork against oxidation, road dirt and fading.

Chromed parts

Chromium-plated and anodized parts should be washed with clean water as soon as they become dirty. This is particularly important if you drive on gravel roads or on roads where salt is used during the winter. After the car has been washed, apply wax or an anti-rust preparation.

Stains on chrome trim can be removed with commercially-available chrome cleaner. Do not use abrasive compounds or steel wool.

pg. 94 Cleaning the upholstery

Cleaning the upholstery

Generally, the fabric can be cleaned with soapy water or a detergent. For more difficult spots caused by oil, ice cream, shoe polish, grease, etc.. use a stain remover.

The **plastic** in the upholstery can be washed. To clean leather upholstery, use soft cloth and mild soap solution, using, for instance, common bath soap.

For more difficult spots, consult your Volvo dealer.

On no account must gasoline, naphtha or similar cleaning agents be used on the plastic or the leather since these can cause damage.

Cleaning the seat belts

Clean only with lukewarm water and mild soap solution.

Cleaning floor mats

The floor mats should be vacuumed or brushed clean regularly, especially during the winter when they should be taken out for drying. Soots on textile mats can be removed with a mild detergent.

Bear in mind

- Take extra care when removing stains such as ink or lipstick since the coloring can spread.
- Use solvents sparingly. Too much solvent can damage the seat padding.
- Start from the outside of the stain and work toward the center.



[Contents](#) | [Top of Page](#)

1989 VOLVO 740

Volvo Service

pg. 95 Service - an investment!

An investment which will pay dividends in the form of improved reliability, durability, and resale value.

Maintenance schedule	96
Volvo service	98
Engine compartment	99
Engine oil	101
Servicing	103
Power steering fluid, brake fluid/clutch fluid	108
Transmission fluid	109
Coolant	110
Lubrication, body	111
Drive belts	112

pg. 96 Servicing

1989 MAINTENANCE SCHEDULE 740

A= Adjust (Correct if necessary)
 R= Replace
 I= Inspect (Correct or Replace if necessary)
 L= Lubricate

Maintenance Operation	Miles	600-1,200	5,000	10,000	15,000	20,000	25,000	30,000	35,000	40,000	45,000	50,000	55,000	60,000 ²
	(Km)	(1,000-2,000)	(8,000)	(16,000)	(24,000)	(32,000)	(40,000)	(48,000)	(56,000)	(64,000)	(72,000)	(80,000)	(88,000)	(96,000)
EMISSION SYSTEM MAINTENANCE														
Engine oil and Oil filter ¹	R	R	R	R	R	R	R	R	R	R	R	R	R	R
Cooling System Hoses and Connections ⁵	I													
Engine Drive Belts	A							I						I

Torque Manifold Nuts	A												
Turbocharger mounting bolts	A												
Valve Clearance ⁴						I							I
Vacuum Fittings, Hoses and Connections ⁵	I												
Air Cleaner Filter						R							R
Spark Plugs						R							R
Fuel System Cap, Tank, Lines and Connections ⁵	I ³												
Torque Catalytic Converter Mounting Bolts	A												
Automatic Transmission Fluid ⁶	I	I	I	I	R	I	I	I	R	I	I	I	R
Manual Transmission Fluid ⁶	R	I	I	I	I	I	I	I	I	I	I	I	I
Rear Axle Oil ⁶	R	I	I	I	I	I	I	I	I	I	I	I	I
Timing Belt (B 230 F/FT)	A										R		
Timing Belt (B 234 F)		A									R	A	

1) For detailed information, see section in Owner's Manual for "Engine Oil"

2) For services beyond 60,000 miles (96,000 km) consult your "Maintenance Record Manual" and "Maintenance Service Chart".

3) Recommended, but not mandatory to maintain Volvo emission warranty.

4) Not B 234 F.

5) Does not pertain to B 230/Regina, B 230 F/EGR and B 234 F.

6) B 230/Regina, B 230 F/EGR and B 234 F: Inspect every 10,000 miles (16,000 km).

pg. 97 Servicing

1989 MAINTENANCE SCHEDULE 740

A= Adjust (Correct if necessary)

R= Replace

I= Inspect (Correct or Replace if necessary)

L= Lubricate

Maintenance Operation	Miles	600-1,200	5,000	10,000	15,000	20,000	25,000	30,000	35,000	40,000	45,000	50,000	55,000	60,000 ²
	(Km)	(1,000-2,000)	(8,000)	(16,000)	(24,000)	(32,000)	(40,000)	(48,000)	(56,000)	(64,000)	(72,000)	(80,000)	(88,000)	(96,000)
MISCELLANEOUS MAINTENANCE														
ENGINE														
Engine Coolant		I		I		I		R		I		I		R
Fuel (Line) Filter														R

PCV Nipple (Orifice)				I				I				I
Ventilation Hoses												I
Battery Charge	I		I		I		I		I		I	I
BRAKES												
Inspect Brakes. Replace components as necessary.			I		I		I		I		I	I
Change Brake Fluid ¹							R					R
STEERING												
Tire Wear (Align front end if needed.)			I		I		I		I		I	I
Check power steering fluid level.		I	I	I		I	I	I		I	I	I
BODY												
Trunk, Door and Hood Hinges and Latches.			L		L		L		L		L	L

1) Recommended, but not mandatory to maintain Volvo emission warranty.

2) For services beyond 60,000 miles (96,000 km) consult your "Maintenance Record Manual" and "Maintenance Service Chart".

3) Does not pertain to B 230/Regina, B 230 F/EGR and B 234 F.

The following items should be checked weekly by the driver (it takes only a few minutes):

Engine oil level

Brake fluid level

Radiator coolant level

Tire pressure (all five tires)

Operation of all lights

Horns

Windshield wipers

Level of windshield washer fluid

The following should also be carried out at regular intervals:

Washing

Polishing

Cleaning

Rust protection

pg. 98 Maintenance service

MAINTENANCE

Maintenance services

Your Volvo has passed two major inspections before being delivered to you, according to Volvo specifications. After being driven 600-1,200 miles (1,000-2,000 km), your car should be brought to the Volvo dealer for a service inspection. Engine, manual transmission and rear axle oils will be changed at this time.

Following this inspection, the maintenance services outlined in this book should be performed every 5,000 miles (8,000 km).

The extended maintenance inspection intervals make it even more advisable to follow this program.

Inspection and service should also be performed any time a malfunction is observed or suspected.

It is recommended that receipts for vehicle emission services be retained in the event that questions arise concerning maintenance. See your "Maintenance Records Manual".

Maintenance inspection at 5,000 mile (8,000 km) intervals

Volvo advises you to follow the inspection program at 5,000 mile (8,000 km) intervals which is outlined in the "Maintenance Records

Manual". This maintenance program contains inspections and services necessary for the proper function of your car over the next 5,000 miles (8,000 km).

The maintenance inspections contain several checks which require special instruments and tools and therefore must be performed by a qualified technician.

To keep your Volvo in top condition, specify time tested and proven Genuine Volvo Parts and Accessories.

The Federal Clean Air Act (USA)

The Clean Air Act requires vehicle manufacturers to furnish written instructions to the ultimate purchaser to assure the proper functioning of those components that control emissions.

The maintenance instructions listed in the "Servicing" section of this Manual represents the minimum maintenance required. These services are not covered by the warranty. You will be required to pay for labor and material used. Refer to your Warranty booklet for further details.

In accordance with Federal Regulations your Volvo is warranted to meet certain Emission Performance Standards. Refer to your Warranty booklet for detailed information.

- Emissions performance warranty (USA)
- Limited 5-year/50,000-mile Emission System Warranty (USA)
- 5-year/80,000-kilometer Emission System Warranty (Canada)

pg. 99 Engine Compartment

740 GL, GLE-16 Valve

- 1 Data plate
- 2 Expansion tank, coolant
- 3 Oil filler cap, engine
- 4 Oil dipstick, engine
- 5 Oil dipstick, automatic transmission
- 6 Brake fluid reservoir
- 7 Oil reservoir, power steering
- 8 Washer fluid reservoir
- 9 Battery
- 10 Engine identification label

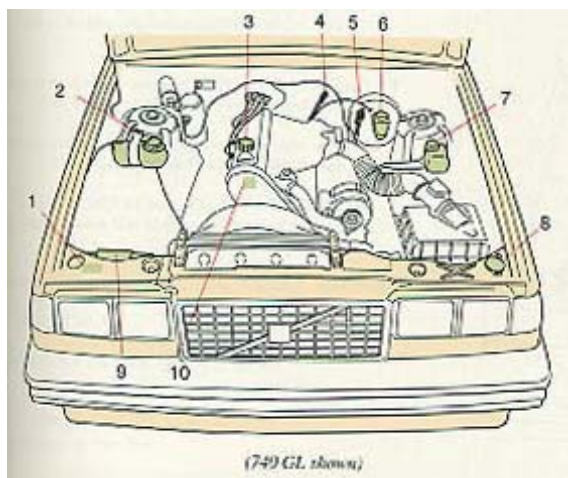

When filling gas always check:

Fuel: Minimum octane requirement: 91 RON (Unleaded) 87 (R+M/2). For improved performance: 95 RON (Unleaded) 91 (R+M/2)
Canada: Unleaded regular

6 Check, without removing the cap, that the **brake fluid level** is above the MIN-mark. Brake fluid DOT 4.

4 Oil level should be between the dipstick marks. The distance between the marks represents approx. 1 US qt. = 1 liter. When necessary, add oil of the same type as already used.

2 Coolant level should be between the expansion tank marks. Mixture 50% anti-freeze and 50% water.

9 Battery-maintenance free type, it is only necessary to check the electrolyte level at each service.

8 Washer fluid reservoir should be filled with water and solvent (wintertime: windshield washer anti-freeze).

Important! Change engine oil and oil filter at 5,000 mile (8,000 km) intervals.

pg. 100 Engine Compartment

740 Turbo

(B 230 F- Turbo engine)

- 1 Washer fluid reservoir
- 2 Expansion tank, coolant
- 3 Oil Filler cap, engine
- 4 Oil dipstick, engine
- 5 Oil dipstick, automatic transmission
- 6 Brake fluid reservoir
- 7 Oil reservoir, power steering
- 8 Battery
- 9 Data plate
- 10 Engine identification label

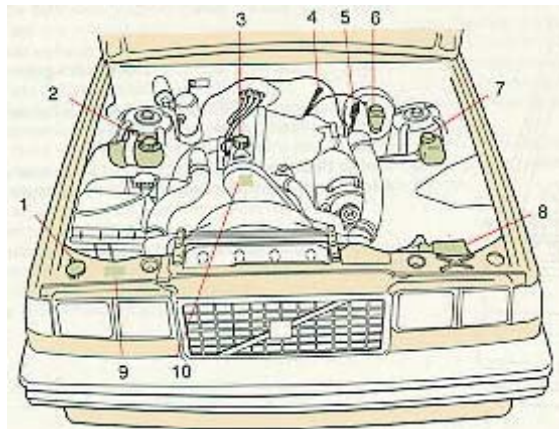

When filling gas always check:

Fuel:

Minimum octane requirement: 91 RON (Unleaded) 87 (R+M/2). For improved performance: 95 RON (Unleaded) 91 (R+M/2)

Canada: Unleaded regular

6 Check, without removing the cap, that the brake fluid level is above the MIN-mark. Brake fluid DOT 4.

4 Oil level should be between the dipstick marks. The distance between the marks represents approx. 1 US qt. = 1 liter. When necessary, add oil of the same type as already used.

2 Coolant level should be between the expansion tank marks. Mixture 50% anti-freeze and 50% water.

8 Battery maintenance free type, it is only necessary to check the electrolyte level at each service.

1 Washer fluid reservoir should be filled with water and solvent (wintertime: windshield washer anti-freeze).

Important! Change engine oil and oil Filter at 5,000 mile (8,000 km) intervals.

pg. 101 Engine Oil

Checking the oil level

The oil level should be checked each time you refuel. Be sure the oil level is maintained between the upper and lower marks on the dipstick. Low oil level can cause internal damage to the engine and overfilling can result in high oil consumption. The distance between the dipstick marks represents approx. 1 US qt (1 liter) of oil.

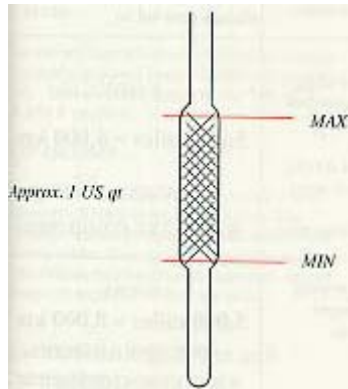

Draining the oil

Drain the oil after driving while it is still hot.

WARNING!

The oil may be very hot.

To add or change engine oil

Add oil of the same kind as already used. Capacity: 4.0 us qts = 3.85 liters incl. filter.*

After an oil change, the oil level will lie between the two marks on the dipstick i.e. between MAX and MIN. This is normal. Do not add too much oil or excessive oil consumption will result.

*if oil cooler (Turbo models) is drained, add 0.7 US qts. (0.6 liters).

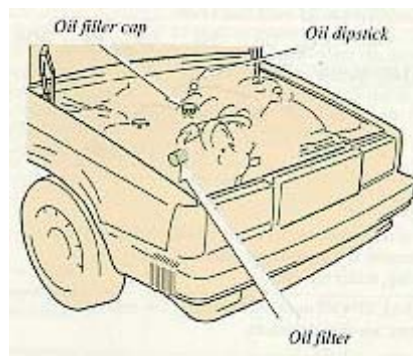

Changing oil Filter

Replace the oil filter at every oil change.

pg. 102 Engine Oil

Oil quality

Meeting API specification SF

Oils with designations SF/CC and SF/CD comply with these requirements.

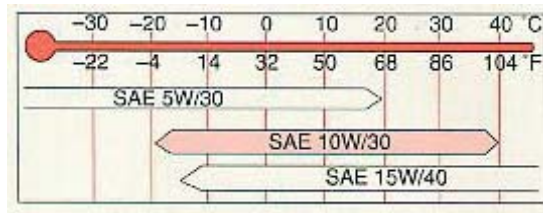
Viscosity (stable ambient temperatures):

SAE 15W/40 is recommended for use in driving conditions that raise oil temperature and increase oil consumption i.e., mountain driving, trailer towing.

NOTE: SAE 15W/40 must not be used at low ambient temperatures; see viscosity chart.

Volvo recommends the use of energy-conserving oils. When using these oils, the Volvo recommended oil-change intervals must be followed.

Synthetic or semisynthetic oils may be used if their specifications comply with the oil quality requirements.

Volvo does not recommend additional oil additives, as they can adversely affect the engine.

Changing oil and oil filter

Oil and oil filter are first changed at the 600-1,200 mile (1,000-2,000 km) service. Thereafter, changes should be made as specified by this table:

If driving conditions include:	Then the correct oil/oil filter change interval is:
<ul style="list-style-type: none"> Extended periods of idling and/or low-speed operation Frequent short trips (less than 7 miles = 11 km) Extended periods of driving in dusty and/or sandy areas Trailer towing Driving mountainous areas 	<p>5,000 miles = 8,000 km or EVERY 3 MONTHS WHICHEVER COMES FIRST</p>
<ul style="list-style-type: none"> Primarily highway driving Frequent trips of longer than 7 miles = 11 km 	<p>5,000 miles = 8,000 km or EVERY 6 MONTHS WHICHEVER COMES FIRST</p>



American Petroleum Institute (API) label. This label certifies that the oil conforms to the applicable standards and specifications of the API.

pg. 103 Servicing

Torque exhaust manifold nuts

The manifold nuts should be torqued at the 600-1,200 mile (1,000-2,000 km) inspection. A loose manifold could alter air/fuel ratio and cause an increase in emissions and/or poor driveability.

Valves

The valve clearance should be checked and, if necessary, adjusted every 30,000 miles (48,000 km). **This does not apply to the 740 GLE (B 234 F engine).**

Air cleaner

Replace the air cleaner cartridge with a new one every 30,000 miles (48,000 km). The cartridge should be replaced more often when driving under dirty and dusty conditions. The filter cannot be cleaned and, therefore, should always be replaced with a new one.

Vacuum fittings, hoses and connections

Unstable idle, misfiring, or poor emission control is often caused by leaking vacuum hoses or connections. Check hoses and connections on distributor vacuum unit, connections on heater control servo systems and hydraulic brake servo.

Checking and adjusting idle speed

Your Volvo is equipped with an electronically-controlled idle speed system that requires no checking or adjustment.

Fuel system cap, tank and lines, and connections

The effectiveness of the fuel system to contain hydrocarbons is dependent largely on a leak-free system. Check for proper sealing of gasoline filler cap which contains "O" ring-type seals. Check all evaporative hoses in vehicle for tightness. Check fuel lines under vehicle and repair if necessary.

Fuel (line) filter

The fuel filter is located next to the fuel pump. This filter is to be changed every 60,000 miles (96,000 km). The Filter is replaced as one complete unit. Replace more frequently if contaminated fuel is introduced into the tank (or if there is reason to suspect that this has occurred).

Timing Gear Belt

The timing gear belt should be adjusted at the 600-1200 mile (1000-2000 km) inspection for engines B230F and B230F Turbo.

For these engines, Volvo recommends the replacement of the timing gear belt every 50,000 miles (80,000 km).

For engine B234F (16 valve) the camshaft timing belt must be re-tensioned at the first 5,000 mile (8000 km) service.

For the B234F (16 valve) the recommended replacement of the timing belt is at every 50,000 miles (80,000 km) and re-tensioned at the following 5000 mile service (example 55,000 mile (88,000 km)).

pg. 104 Servicing

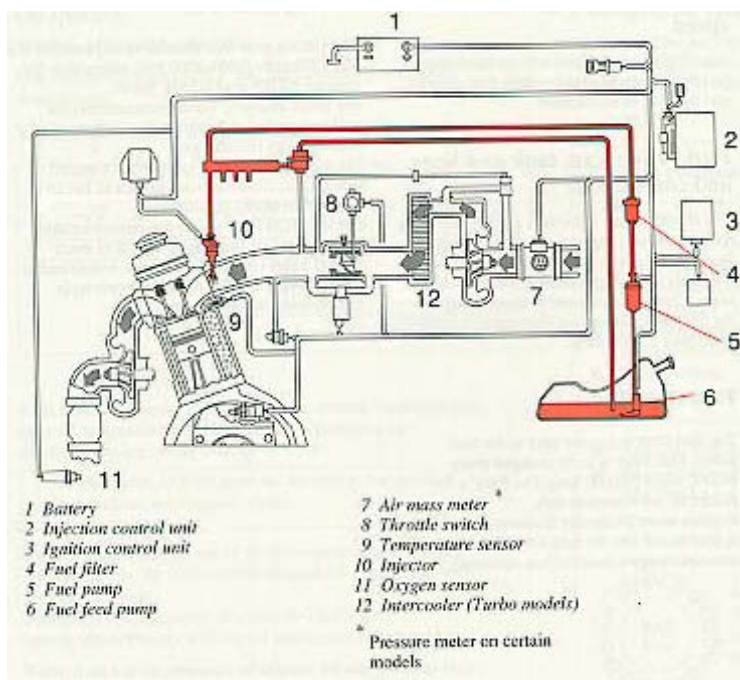

Fuel system

The fuel injection system is all-electronic and is microprocessor-controlled. It can continually compensate for variations in engine load, speed and temperature to give the best economy and power. An air mass meter, or a pressure meter on certain models measures the inducted air. In this way the system can make instantaneous adjustments for changes in air temperature or density, thus always assuring the best economy with the lowest possible exhaust emission.

Lambda-sond (oxygen sensor) system

This is an emission control system designed to reduce emissions and improve fuel economy. An oxygen sensor monitors the composition of the exhaust gases leaving the engine. The exhaust gas analysis is fed into an electronic unit which continually influences the injectors. This adjusts the air-fuel ratio to provide optimum conditions for combustion and efficient reduction of the three major pollutants (hydrocarbons, carbon monoxide and nitrous gases) by a 3-way catalytic converter.

pg. 105 Servicing

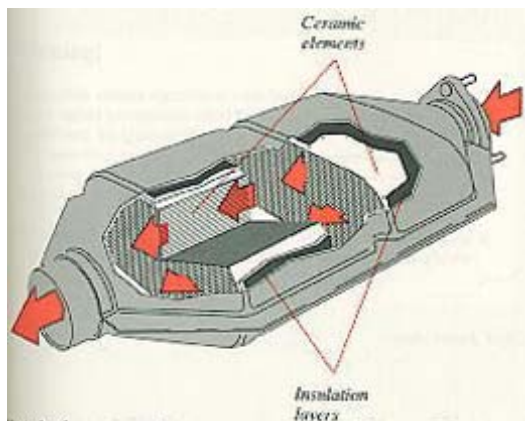

Catalytic converter

This is a supplementary device in the exhaust system, designed to clean exhaust gases.

This device is mainly a container with a ceramic material insert, designed to let the exhaust gases pass through channels in the insert. The channel walls are covered by a thin layer of platina-palladium. These metals act as catalysts, permitting chemical reaction to occur without actually taking part in it.

The emission (CO, HC, NOX) content will increase if the catalytic converter is damaged. Lambda-sond equipped vehicles use Catalytic Converters containing platinum and rhodium.

Torque Catalytic Converter mounting bolts

The Catalytic Converter mounting bolts should be torqued after the first 600-1,200 miles (1.000-2,000 km).

Caution: Vehicles with Catalytic Converter must use unleaded fuel only. Otherwise the Catalytic Converter will become ineffective. See "Fuel requirements".

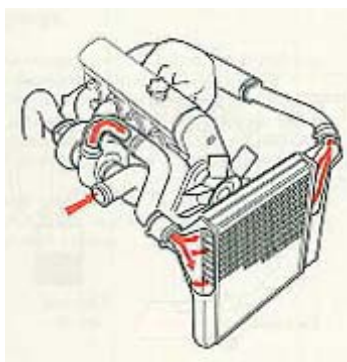

Intercooler

The B230F-Turbo engine employs a turbo-compressor to force air into the engine inlet manifold and an intercooler to cool the compressed inlet air. The resulting increase in air flow raises pressure in the intake manifold by approx. 8 psi (over atmospheric pressure) and engine power output by approx. 46 horsepower over that developed by the normally- aspirated engine.

The intercooler (which resembles a radiator) is located between the turbo-compressor and inlet manifold.

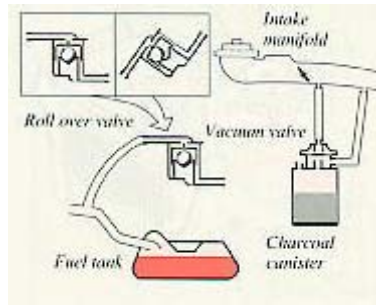

Evaporative control system

The 740 is equipped with a gas-evaporative control system, which prevents gasoline fumes from being released into the atmosphere. The system is comprised of an expansion chamber in the fuel tank, a roll-over valve on the cross member in front of the fuel tank, and a charcoal canister with built-in vacuum valve under the left-front wheel housing. The components are interconnected by hoses which channel fuel vapor from the gas tank to the charcoal filter, where it is stored until the engine is started and then drawn into the engine's fuel-induction system.



Crankcase ventilation

The engine is equipped with positive crankcase ventilation which prevents crankcase gases from being released into the atmosphere. Instead, the crankcase gases are admitted to the intake manifold and cylinders.

PCV system

The PCV nipple in the intake manifold should be removed and cleaned after 60,000 miles (96,000 km). Check/replace hoses at the same time.

Exhaust Gas Recirculation (EGR)

This system operates by returning some of the exhaust gases to the engine to be recombusted: since this lowers the combustion temperature the amount of nitrogen oxides released into the atmosphere is reduced.

The EGR valve should be inspected every 12,000 miles (20,000 km) and cleaned even 24,000 miles (40,000 km).

WARNING!

The ignition system operates at very high voltages. Special safety precautions must be followed to prevent injury. Always turn the ignition off when:

- Connecting engine test and diagnostic equipment to the vehicle (timing light, tach-dwell tester, ignition oscilloscope, etc).
- Replacing ignition components e.g. plugs, coil, distributor, HT leads etc.
- Do not touch any part of the ignition system while the engine is running. This may result in unintended movements and body injury.

Replacing spark plugs

The spark plugs should be changed every 30,000 miles (48,000 km). However, city driving or fast highway driving may necessitate changing after 15,000 miles (24,000 km) of driving. When installing new plugs, be sure to fit the right type and use correct torque, see "Specifications". When changing the plugs, check that the suppressor connectors are in good condition. Cracked or damaged connectors should be replaced.

When changing spark plugs, clean the cables and cable terminals, also the rubber seals. If the car is driven on roads where salt is used during the winter, coat the cables with silicone.

pg. 108 Brake fluid/clutch fluid, Power steering fluid

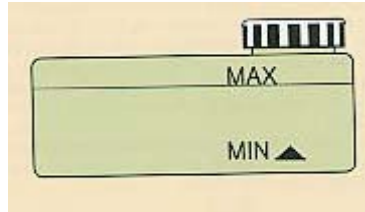

Brake fluid/Clutch fluid

The fluid level should be above the min mark.

Fluid type: DOT 4

Replace: Every second year or 30,000 miles (48,000 km). The brake fluid should be replaced once a year or every 15,000 miles (24,000 km) when driving under extremely hard conditions (mountain driving etc.)

Check, without removing the cap, that the level is above the "MIN" mark of the fluid reservoir.

Always entrust brake fluid changing to an authorized Volvo dealer.

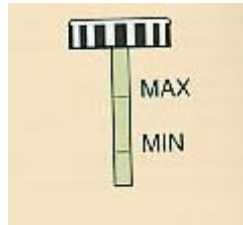

Power steering fluid

The fluid level should lie between the MIN and MAX marks on the dipstick (cool engine).

Check fluid level with engine idling and after driving while the fluid still is hot. Wipe the reservoir clean.

Fluid type: ATF

Replace: No fluid change required

pg. 109 Automatic transmission

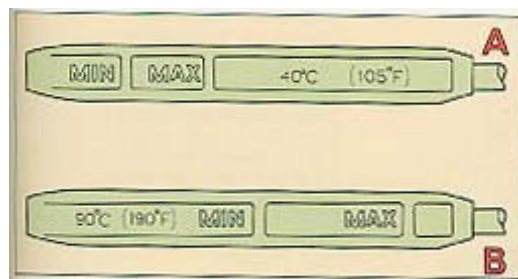

Automatic transmission oil

Capacity: See "Specifications" section.

Fluid type: Automatic Transmission Fluid type Dexron IID.

Replace: Every 20,000 miles (32,000 km).

WARNING!

Oil spilled on a hot exhaust pipe constitutes a fire risk.

A Cold transmission: oil temperature +105°F (+40°C). This is a normal temperature for the transmission after idling for about 10 minutes. At oil temperature below +105°F (+40°C), the level may be below the MIN mark.

B Warm transmission: oil temperature +190°F (+90°C). This temperature is reached after driving for about 30 minutes. At oil temperature above +195°F (+90°C), the level may be above the MAX mark.

NOTE:

The engine should be idling when checking transmission fluid level.

Check the oil level as follows:

Park the car on level surface with the engine idling. Slowly move the selector lever through all the gear positions and then to position P. Wait 2 minutes before checking the oil level. As the illustration shows, the dipstick has a "Cold" and a "Warm" side. The oil level should be between the MIN and MAX marks. Wipe the dipstick with a clean cloth.

WARNING!

The oil may be very hot

Do not use rags that could leave lint on the dipstick. The transmission is topped up via the dipstick tube. The space between the MIN and MAX marks on the dipstick corresponds to 0.5 US qt. (0.5 liter). Do not Fill the transmission with too much oil, since this can result in oil being ejected from the transmission.

Too little oil, on the other hand, can negatively affect transmission operation, particularly in very cold weather.

pg. 110 Cooling system

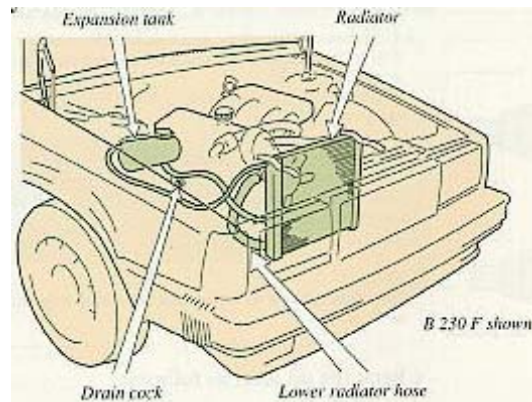
**Check coolant level**

The cooling system must be filled with coolant and not leak to operate at maximum efficiency. Check the coolant level when filling fuel. The level should be between the "MAX" and "MIN" marks on the expansion tank. The check should be made with particular thoroughness when the engine is new or when the cooling system has been drained.

Do not remove the filler cap other than for topping-up with coolant. Frequent removal may prevent coolant circulation between the engine and the expansion tank during engine warm-up and cooling.

Changing coolant

Every two years or 30,000 miles (50,000 km) the cooling system should be drained, flushed and refilled.

Remove the expansion tank cap. Open the drain cocks on both sides of the engine block and disconnect the lower radiator hose.

Fill coolant through the expansion tank. The heater controls should be fully open when draining and Filling.
Add coolant until the level is up to the MAX mark or slightly above.

Start engine and run until hot. Check the cooling system connections for tightness. Also re-check the coolant level.
Capacity: See "Specifications"
Coolant: Volvo coolant type C (blue green)

Caution!

The cooling system must always be kept filled to correct level. If it is not kept filled, there can be high local temperature in the engine which could result in damage.

Top up with coolant

Top up with coolant by filling the expansion tank when level is at the "MIN" mark. Use a mixture of 50 percent anti-freeze/summer coolant and 50 percent water all year round. Top up to the "MAX" mark.

WARNING!

If the engine is warm, and you are going to top up coolant, unscrew the cap slowly in order to allow any excess pressure to escape.

NOTE: Do not top up with water only. Water by itself reduces the rust-protective and antifreeze qualities of the coolant and has a lower boiling point. It can also cause damage to the cooling system if it should freeze.

pg. 111 Lubrication

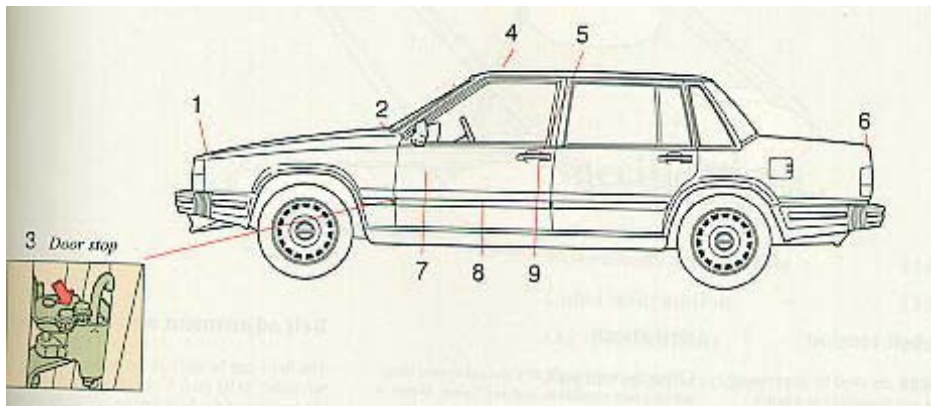

No. Lubricating point

- 1 Hood lock and latch
- 2 Hood hinges
- 3 Door stop and hinges
- 4 Sunroof wind deflector
- 5 Door lock catch plate
- 6 Trunk lid lock
- 7 Window regulator Locking device (on inside of door)
- 8 Front seat slide rail and latch
- 9 Door lock key hole

Lubricant

- Paraffin wax
- Oil
- Oil
- Oil
- Paraffin wax or low temperature grease
- Volvo Teflon lock oil
- Oil, grease Silicone grease
- Oil
- Low temperature grease or Volvo Teflon lock oil.

To avoid rattles and unnecessary wear, the body should be lubricated a few times per year.

pg. 112 Drive belt

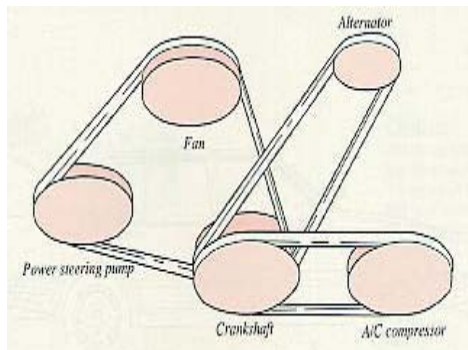

Checking the belt tension

The belt tension can be checked by depressing the fan belt (engine not running!) at a point midway between the alternator and fan. It should be possible to press down the belt about 1/4"-3/8" (5-10 mm). This also applies to other drive belts on the engine.

Belt check

Check the belts regularly to make sure they are in good condition and are clean. Worn or dirty belts can cause poor cooling and low alternator output as well as impair the operation of the power steering and the air conditioning unit.

Belt adjustment and replacement

The belts can be difficult to reach and it is advisable to let your Volvo dealer adjust the tension of the belts or replace them if necessary.



[Contents](#) | [Top of Page](#)

1989 VOLVO 740

Specifications

pg. 113 Specifications

Dimensions and weights	114
Label information	115
Oil specifications	116
Engine specifications	117
Electrical system specifications	120
Capacities	121

pg. 114 Specifications

	740 GL	740 TURBO	740 GLE-16 valve
Dimensions and weights			
Length	188.4"	478.5 cm	
Width	68.9"	175 cm	
Height	56.5"	143 cm	
Wheelbase	109"	277 cm	
Track:			
front	57.5"	146 cm	
rear	57.5"	146 cm	
Turning circle, between curbs	32.5 ft	9.9 m	
Trunk capacity (sedans)	16.8cu.ft.	0.487 m	
Cargo capacity (wagons)			
With rear seats up	39.3 cu. ft.	1.1 m	
With rear seats down	74.9 cu. ft.	2.1 m	

Gross Vehicle Weight (GVW):

GL/GLE-16 Valve (sedan)	3965 Lbs. 1800 kg
Turbo (sedan)	4050 Lbs. 1840 kg
GLE Wagons	4275 Lbs. 1920 kg
Turbo wagon	4295 Lbs. 1950 kg
Capacity weight (sedan)	1000 Lbs. 455 kg
Capacity weight (740 GLE-16 Valve wagon)	1045 Lbs. 475 kg
Capacity weight (740 Turbo wagon)	1035 Lbs. 470 kg
Permissible axle weight, front:	
GL, GLE-16 Valve	1940 Lbs. 880 kg
Turbo	2050 Lbs. 930 kg
Permissible axle weight, rear:	
GL, GLE-16 Valve (sedan)	2030 Lbs. 922 kg
Turbo (sedan)	2090 Lbs. 950 kg
Wagon	2310 Lbs. 1050 kg
Max. roof load	220 Lbs. 100 kg
Max. trailer weight	3300 Lbs. 1500 kg
Curb weight (sedan)	2943-3075 Lbs. 1336-1395 kg
Curb weight (wagon)	3082-3203 Lbs. 1399-1454 kg

The max permissible axle loads must not be exceeded

WARNING!

When adding accessories, equipment, luggage and other cargo to your vehicle, the total loaded weight capacity of the vehicle must not be exceeded.

Consult your Volvo dealer for information.
All specifications are subject to change without notice.

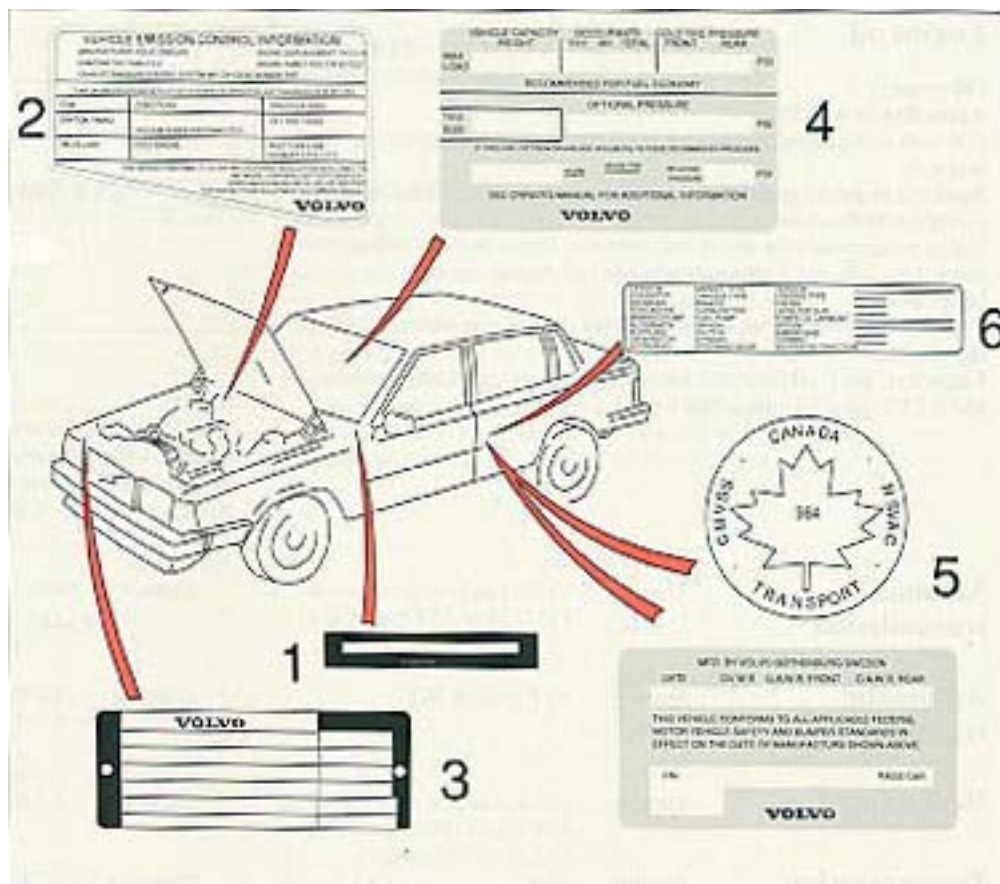

The Vehicle Identification Number (VIN) should always be quoted in all correspondence concerning your vehicle with the dealer and when ordering parts.

1 Vehicle identification number (VIN)

VIN plate is located on top left surface of dashboard. The VIN is also stamped on the right hand door pillar.

2 Vehicle emission control information

Your Volvo is designed to meet all applicable safety and emissions standards, as evidenced by the certification label on the right side of the firewall. For further information regarding these regulations, please consult your Volvo dealer.

3 Model plate

Vehicle Identification Number (VIN). Codes for color and upholstery etc. This plate is located on panel above right headlight.

4 Loads and tire pressures

Label on right-front door frame.

5 Federal motor vehicle safety standards (FMVSS) specifications (USA) and Ministry of Transport (CMVSS) Standards (Canada)

This label is located on rear-facing side of the driver's door.

6 Service label

Label on left-rear door frame. Information on certain components.

All specifications are subject to change without notice.

pg. 116 Specifications

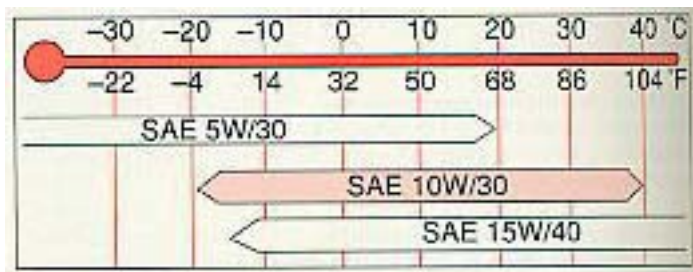

Engine Oil

Oil quality:

According to API SF.

Oils with designation SF/CC and SF/CD comply with these demands.

Synthetic or semi-synthetic oils may be used if their specifications comply with the above.

Volvo recommends the use of fuel economy improving oils. When using these oils, the Volvo recommended oil change intervals must be followed.

Volvo does not recommend oil additives as they can adversely affect the engine.

Capacity: (incl. oil filter) 4.0 US qts. (3.85 liters); on Turbo models, add 0.7 US qts. (0.6 liters) if oil cooler is drained.

Manual transmission	Quality	Volvo synthetic gearbox oil 1161324 or ATF type F or G	Capacity	(M46) 2.4 US qts. (2.3 liters) (M47) 1.6 US qts. (1.5 liters)
Automatic transmission	Quality	ATF Dexron IID	Capacity	7.9 US qts. (7.5 liters)
Rear axle	Quality	Volvo rear axle oil 1161329 or API-GL-5 (MIL-L-2105 B or C) SAE 90 or 80W/90	Capacity	1.7 US qts. (1.6 liters)
Power steering	Quality	ATF	Capacity	0.7 US qts. (0.7 liter)
Brake fluid	Brake fluid type	DOT 4	Capacity	0.66 US qts. (0.5 liter)

NOTE:

SAE 15 W/40 oil is recommended for use in severe driving conditions which involve high oil temperatures or excessive oil consumption e.g. mountain driving with frequent deceleration, or high-speed driving. Note, however, the higher temperature range of 15W/40 oil.

pg. 117 Specifications

**740 GL
(B230F engine)**

Type designation	Volvo B230F
Output (SAE J 1349)	114 hp at 5400 rpm (85 kW at 90 rps)
Max. torque (SAE J 1349)	136 ft. lbs. (185 Nm) at 2500 rpm
Number of cylinders	4
Bore	3.78" (96 mm)
Stroke	3.15" (80 mm)
Displacement	2.32 Liters
Compression ratio	9.8:1
Valve clearance, cold engine inlet and exhaust	0.014-0.016" (0.35-0.40 mm)
Valve clearance, warm engine inlet and exhaust	0.016-0.018" (0.40-0.45 mm)

**740 GLE-16 valve
(B 234 F engine)**

Type designation	Volvo B 234 F
Output	153 hp at 5700 rpm (114 kW at 95 rps)
Max. torque	150 ft. lbs. (203 Nm) at 4450 rpm
Number of cylinders	4
Bore	3.78" (96 mm)
Stroke	3.15" (80 mm)
Displacement	2.32 Liters
Compression ratio	10.0:1
Valve clearance	Self-adjusting

740 Turbo (B230F-Turbo engine)

Type designation	Volvo B230F-Turbo
Output (SAE J 1349)	160 hp at 5300 rpm (119 kW at 88 rps)
Max. torque (SAE J 1349)	187 ft. lbs. (253 Nm) at 2900 rpm
Number of cylinders	4
Bore	3.78" (96 mm)
Stroke	3.15" (80 mm)
Displacement	2.32 Liters
Compression ratio	8.7:1
Valve clearance, cold engine inlet and exhaust	0.014-0.016" (0.35-0.40 mm)
Valve clearance, warm engine inlet and exhaust	0.016-0.018" (0.40-0.45 mm)

All specifications are subject to change without notice.

pg. 118 Specifications

Cooling system

Type	Positive pressure. Closed system
Thermostat: begins to open at: (GL, GLE-16 Valve)	189 °F (87 °C)
(Turbo)	198° F (92°C)
Fan belts, designation: (GL, GLE-16 Valve)	HC47cog x 1013
(Turbo)	HC47cog x 1000
Coolant:	Volvo coolant type C (blue-green)
Capacity:	10 US qts (9.5 liters)

Ignition system

Firing order	1-3-4-2
--------------	---------

Ignition setting: (GL)	12° B.T.D.C . at 750 rpm
(GLE 16 valve)	12° B.T.D.C . at 850 rpm
(Turbo)	12° B.T.D.C . at 750 rpm
Spark plugs: (GL Turbo)	Volvo P/N 271409-5 *
(GLE-16 valve)	Volvo P/N 1367529 *
Spark plug gap	0.024-0.028" (0.6-0.7 mm)
Tightening torque	15-22 ft. lbs. (20-30 Nm)
Distributor, direction of rotation	Clockwise

Volvo P/N 271409-5 = Bosch WR7DC

Volvo P/N 1367529 = Bosch WR6DC

pg. 119 Specifications

Power transmission

Manual or automatic transmission.

Hypoid type Final drive.

Manual transmission

M46 M47

Reduction ratios:

1st gear	4.03:1	4.03:1
2nd gear	2.16:1	2.16:1
3rd gear	1.37:1	1.37:1
4th gear	1:1	1:1
5th gear	-	0.82:1
Overdrive	0.78:1	-
Reverse	3.68:1	3.68:1

Rear Axle : 3.73:1

Reduction ratios: 3.54:1

3.31:1

Automatic transmission AW70L & AW71

Reduction ratios:

1st gear	2.45:1
2nd gear	1.45:1
3rd gear	1:1
4th gear	0.69:1
Reverse	2.21:1

Rear Axle : 4.10:1

Reduction ratios: 3.73:1

Automatic transmission AW72 (740 GLE-16 Valve)

Reduction ratios:

1st gear	2.83:1
2nd gear	1.49:1
3rd gear	1:1
4th gear	0.73:1
Reverse	2.70:1

Rear Axle :

Reduction ratios: 4.10:1

Speeds at 1000 engine rpm (manual transmission)

Rear axle ratio	3.73:1		3.54:1		3.31:1	
	mph	km/h	mph	km/h	mph	km/h
1st gear	5.0	8.0	5.0	8.0	5.3	9.0
2nd gear	8.8	14.0	9.2	14.8	9.8	16.0
3rd gear	14.4	23.0	14.5	23.4	15.5	25.0
4th gear	19.4	31.0	19.9	32.1	21.3	35.0

Overdrive/5th gear	25.0	40.0	25.2	40.6	26.9	42.0
Reverse	5.0	8.0	5.4	8.7	5.8	10.0

Front end

McPherson-type spring and strut suspension. Shock absorbers housed in strut casing. Rack-and-pinion steering.

Safety-type steering column.

The alignment specifications apply to an unloaded car but include fuel, coolant, and spare wheel.

Toe-in, measured on the wheel rim: 5/64" +/- 1/64" (2 mm +/- 0.5 mm)

tire sides: 3/32" +/- 1/32" (2.5 mm +/- 1 mm)

All specifications are subject to change without notice.

pg. 120 Specifications

Electrical system

12 V, negative ground.

Voltage-controlled alternator engine used as conductors.

Voltage	12V
Battery, type	Maintenance free
Capacity	450A/90 min (GLE 16 valve 500A/90 min)
Electrolyte, specific gravity	1.28
Recharge at	1.23
Alternator, rated output	1120 W (GL,GLE-16 Valve), 1400 W (Turbo)
max. current	80 A (GL,GLE-16 Valve) 100 A (Turbo)

The following bulbs may be obtained from your nearest Volvo dealer

Lights, 12 V	US Bulb No.	Power	Socket
Headlights, inner	H4651	Halogen	Sealed beam
Headlights, outer	H4656	Halogen	Sealed beam

Parking lights, front	1157NA	21/5W/24/2.2 cp	BAY 15 d
Turn signals, front	1157NA	21/5W/24/2.2 cp	BAY 15 d
Turn signals, rear	1156	21 W/32 cp	BA 15 s
Tail lights	67	5 W/4 cp	BA 15 s
Tail light/brake light	1157	21/5W/32/3 cp	BAY 15 d
High-mounted brake light		21 W/32 cp	BA 15 s
Back-up lights	1156	21 W/32 cp	BA 15 s
Rear fog lights	1156	21 W/32 cp	BA 15 s
Fog lights		55 W	H3
License plate light		4 W	BA 9 s
Rear side marker light		4 W	BA 9 s
Door warning lights		3 W	W 2.1 x 9.5d
Interior light		10 W	SV 8.5
Reading lights, front		5 W	W 2.1 x 9.5d
Engine compartment light		10 W	SV 8.5
Trunk light		10 W	SV 8.5
Glove box light		2 W	BA 9 s
Instrument lighting		3 W	W 2.1 x 9.5d
Lighting, control panel		1.2 W	Volvo P/N 966326
A/T selector		1.2 W	Volvo P/N 966326
Ashtray, rear		1.2 W	Volvo P/N 966326
Warning lights/Indicator lights		1.2 W	Volvo P/N 966326

pg. 121 Specifications

Vehicle Loading

The tires on your Volvo should perform to specifications at all normal loads when inflated as recommended on the tire information label. The label is located on the rear-facing edge of the right front door. This label lists both tire and vehicle design limits. Do not load your car beyond the load limits indicated.



WARNING!

Improperly inflated tires will reduce tire life, adversely affect vehicle handling and can possibly lead to failure resulting in loss of vehicle control without prior warning.

Tool kit

Wheel nut wrench.

2 screwdrivers (1 Phillips, 1 standard)

Pry bar

2 open end wrenches.

Capacities

Fuel tank (approx.)	15.8 US gal. 60 liters
Cooling system	10 US qts. 9.5 liters
Engine, at oil change	4.0 US qts.* 3.85 liters
Manual transmission	
(M46)	2.4 US qts 2.3 liters
(M47)	1.6 US qts. 1.5 liters
Automatic transmission	7.9 US qts. 7.5 liters
Automatic transmission	
Rear axle	1.7 US qts. 1.6 liters
Power steering gear	0.7 US qts. 0.7 liters
*Turbo: If oil cooler is drained, add 0.7 US qts (0.6 liters)	

All specifications are subject to change without notice.

Service Manuals for your Volvo are available for purchase. These are the same manuals used by competent Volvo technicians. Major sections within the Service Manual System include: 0-General Information; 1- Lubrication and Service; 2-Engine; 3-Electrical System; 4-Power Transmission; 5- Brakes; 6- Suspension and Steering; 7-Springs, Shock absorbers and Wheels; 8-Body and Interior. A Service Manual Brochure/Order Form was placed in the car prior to delivery from the dealer to you. Complete ordering information is provided.

Please note that these manuals may be offered for sale by your Volvo dealer. Prices charged by the dealer can vary from those listed in the brochure (according to Federal law).

Additional copies of the Brochure/Order Form may be obtained from your Volvo dealer, or by mail directly from:

Volvo Cars of North America
Rockleigh Industrial Park
Rockleigh, New Jersey 07647
Attention: Volvo Service Literature

Note! The above pertains to USA only.



Volvo supports Voluntary Mechanic Certification by the N.I.A.S.E. Certified mechanics have demonstrated a high degree of competence in specific areas.

Besides passing exams each mechanic must also have worked in the field for two or more years before a certificate is issued. These professional mechanics are fully able to analyze vehicle problems and perform the necessary service procedures to keep your Volvo at peak operating condition.

Note! The above pertains to USA only.

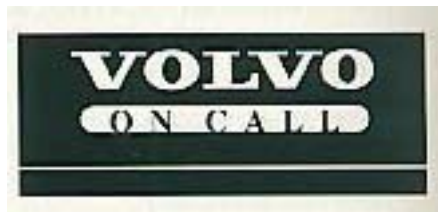

Your new Volvo comes with a three year road assistance program named ON-CALL. Additional information, features, and benefits are described in a separate information package in your glove compartment.



[Contents](#) | [Top of Page](#)

1989 VOLVO 740

Index

pg. 123-124 Specifications

A	
ABS	12 , 61
Air conditioning	24 , 25
Air louvers	23
Alternator, important note	55
Anti-freeze	110
Anti-rust treatment	88
Ash trays	20
Automatic transmission, driving with	49
Automatic transmission, oil	109
B	
Battery	120
Body and chassis	111
Brake fluid	108
Brakes	61
Break-in period	46
Bulb failure warning light	10 , 11
Bulbs	73 , 120
C	
Capacities	121
Car care	87
Catalytic converter	60

Chassis number	115
Check coolant	110
oil	101
Child restraint anchorage	31
Child safety	30
Child safety locks	37
Cigarette lighter	20
Climate control	23-25
Clock	8
Clutch fluid	108
Cold start	48
Cold weather driving	63
Control lights	10
Coolant	110
Coolant, drain	110
Cooling system	110
Cruise control	16
D	
Defroster	23-25
Demister(rear window)	19
Diagnosis	84
Dimensions and weights	114
Dipstick	101
Doors and locks	36
Drain plug, engine	101
Drive belts	112
Driving economy	56
Driving with trunk lid open	54
E	
Electrical system	120
Emergency towing (pulling)	57
Engine number	99-100

Engine	99-100
Engine oil	101-102
F	
Fan belts	112
Fault tracing	84
Federal clean air act	98
Fog lights	18
Front seats	27
Front wheel alignment	119
Fuel requirements	47
Fuel gauge	8
Fuel tank cap	47
Fuses	80-82
G	
Gas filler cap	47
Gasoline requirements	47
Gear shift positions	50-53
H	
Hand Brake	20
Hazard warning flasher	14
Headlight flasher	14
Headlights	17
replacement	73
Heating	23, 24, 25
Hood lock	39
Horn	6
I	
Ignition and steering wheel lock	13
Instrument lights	8
Instrument and controls	6
Interior light	29

J

Jack	72
Jump start	59

K

Keys	5
Kick-down	52

L

Label information	115
License plate lights	77-78
Lights	17
Locks	5 , 36
Long distance trips	64
Lubrication	111
Lumbar support	27

M

Maintenance service	96
Manual transmission, driving with	53
Multipath distortion	22

O

Odometer	8
Oil change, engine	101-102
transmission	109
Oil filter	101-102
Oil pressure	11
On-call	122
Overdrive	53

P

Paint touch-up	90
Parking brake	20
Parking lights	17
Polishing	93
Power steering fluid	108

Power train	119
R	
Radios	22
Rear foglights	18
Rear view mirrors	28
Rear window demister	19
Refueling	47
Rustproofing	88
Rust protection	88
S	
Seat belts	32
Seats	27
Service diagnosis	84
Servicing	96
Shift indicator light	12
Shift positions	50-53
Shop manuals, Volvo	122
Snow chains	67
Snow tires	67
Spare wheel	70
Spark Plugs	107, 118
Specifications	113
Speedometer	8
SRS Supplemental Restraint System	34
Starting engine	48
Starting key	5
Steering wheel lock	13
Storage space	40
Sunroof	29
T	
Tachometer	8
Tailgate (wagon)	41

Temperature gauge	8
Tire pressure	68
Tires	66
Tire wear indicator	67
Tools	121
Touch up	90
Towing	58
Towing a trailer	62
Trunk	37
Turn signals	14
Type designations	115
U	
Upholstery, cleaning	94
V	
Vehicle identification number	115
Ventilation outlets	23
VIN (Vehicle Identification Number)	115
Volvo On Call	122
W	
Warning lights	10
Warranty	98
Warranty inspection	98
Washer fluid	15 , 63
Washer nozzles	15
Washing	92
Waxing	93
Weights	114
What causes rust	88
Wheel alignment	119
Wheel change	71
Wheels and tires	66

Window lifts	21
Windshield washers	15
Windshield wipers	15
Winter driving	63
Wiper blades, replacement	83

WARNING!

Detergents and solvents

Do not use gasoline containing lead or benzene as a detergent or solvent. Both lead and benzene are toxic and may be hazardous to your health

WARNING!

Carbon monoxide is a poisonous colorless and odorless gas which is present in all exhaust gases. If you ever smell exhaust fumes inside the vehicle, make sure the passenger compartment is ventilated and immediately return the vehicle to dealer for correction. Never sit in a parked or stopped car for any extended amount of time nor have it unattended while engine is running.

Never operate the engine in confined, unventilated areas.



[Contents](#) | [Top of Page](#)